



Surgical Technique



Summary

| | |
|--|----|
| Concept and range | 5 |
| Surgical technique overview | 8 |
| Step 1 - Pre-operative planning | 10 |
| Step 2 - Acetabulum reaming..... | 11 |
| Step 3 - Reaming control..... | 12 |
| Step 4 - Holding the cup | 14 |
| Step 5 - Final cup impaction..... | 15 |
| Step 6 - Trials with trial liner (optional)..... | 17 |
| Step 7 - Head impaction in the liner | 18 |
| Step 8 - Final implant reduction | 19 |
| Instrumentation..... | 22 |
| Annex A..... | 28 |
| Annex B..... | 29 |
| Annex C..... | 30 |



Concept and range

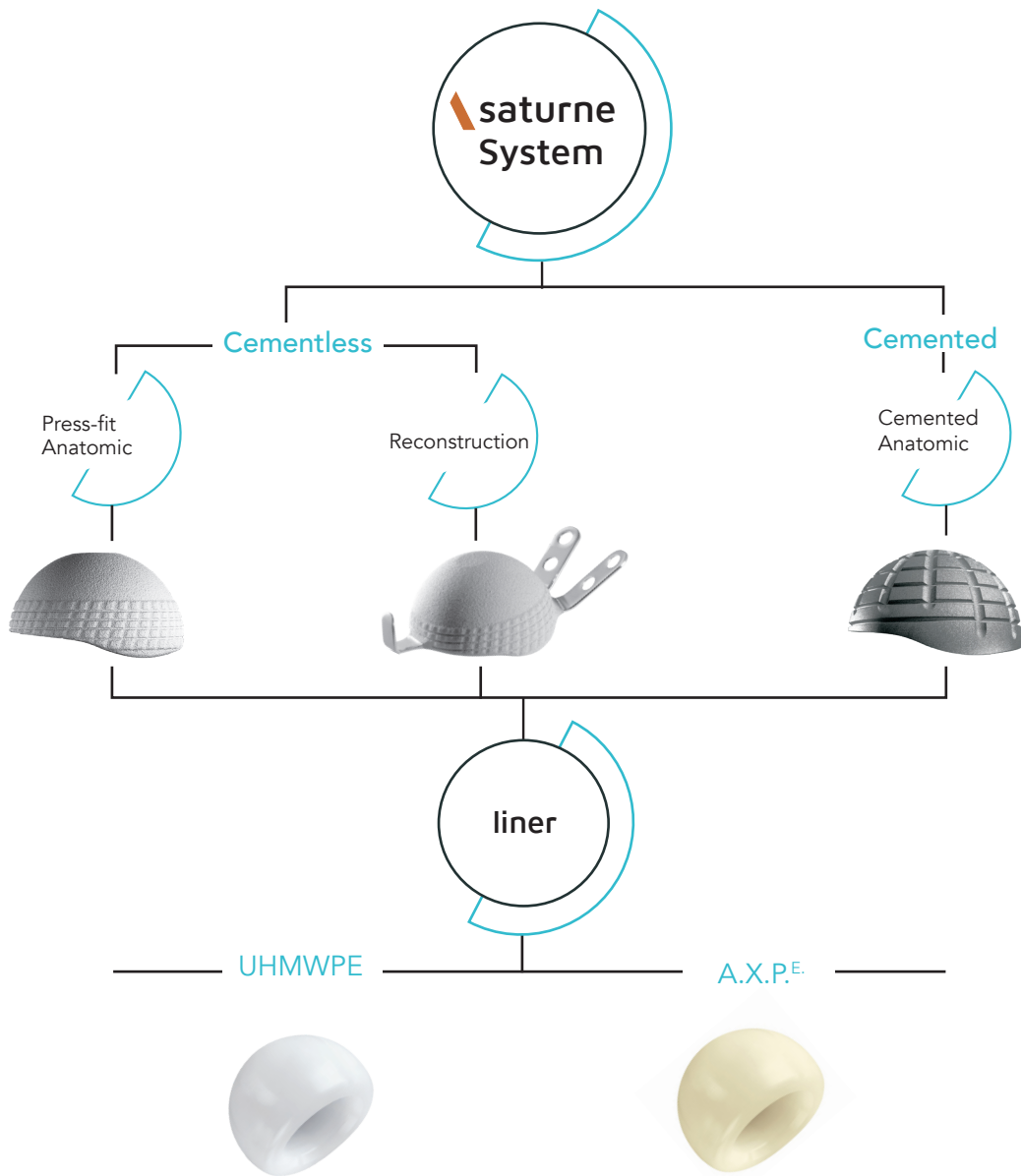

| | | Ø44 mm | Ø46 mm | Ø48 mm | Ø50 mm | Ø52 mm | Ø54 mm | Ø56 mm | Ø58 mm | Ø60 mm | Ø62 mm | Ø64 mm | Ø66 mm |
|------------|------------------------|----------------|--------|--------|--------|--------|--------|--------|--------|--------|--------|--------|--------|
| | | SATURNE system | | | | | | | | | | | |
| Cementless | Saturne cementless | | | | | | | | | | | | |
| | Saturne reconstruction | | | | | | | | | | | | |
| | Saturne cemented | | | | | | | | | | | | |
| Cemented | Liner** Ø22,2 mm | | | | | | | | | | | | |
| | Liner** Ø28 mm | | | | | | | | | | | | |

* optional sizes available on request
 ** UHMWPE or A.X.P.E.

Concept and range

SATURNE cementless

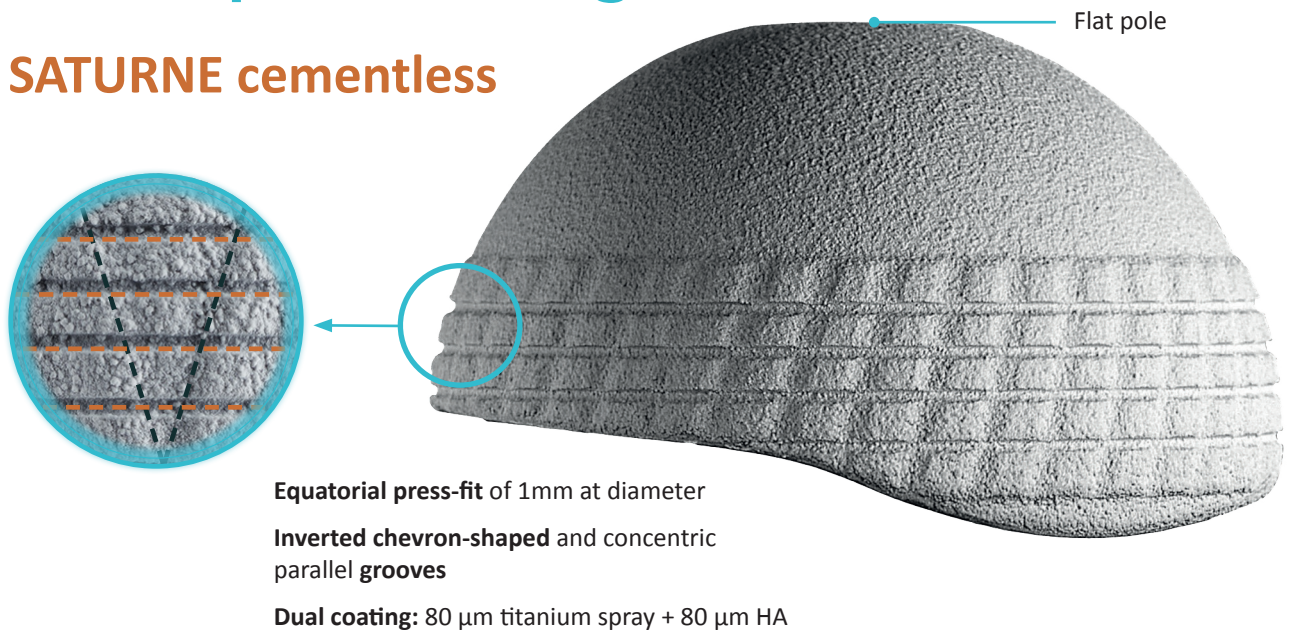

SATURNE reconstruction

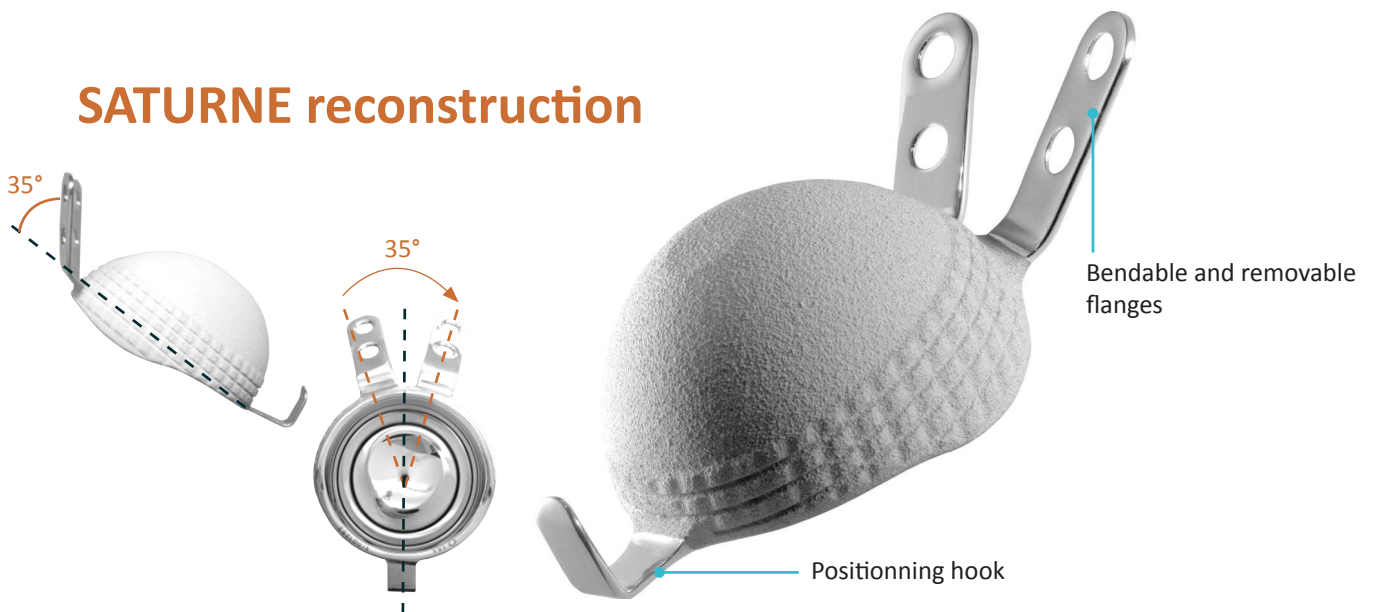

SATURNE cemented

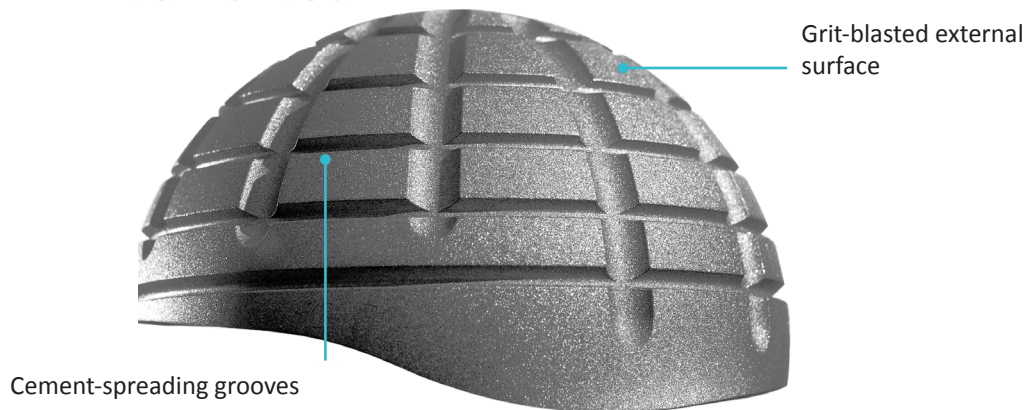

Material for all versions: Stainless Steel



Concept and range

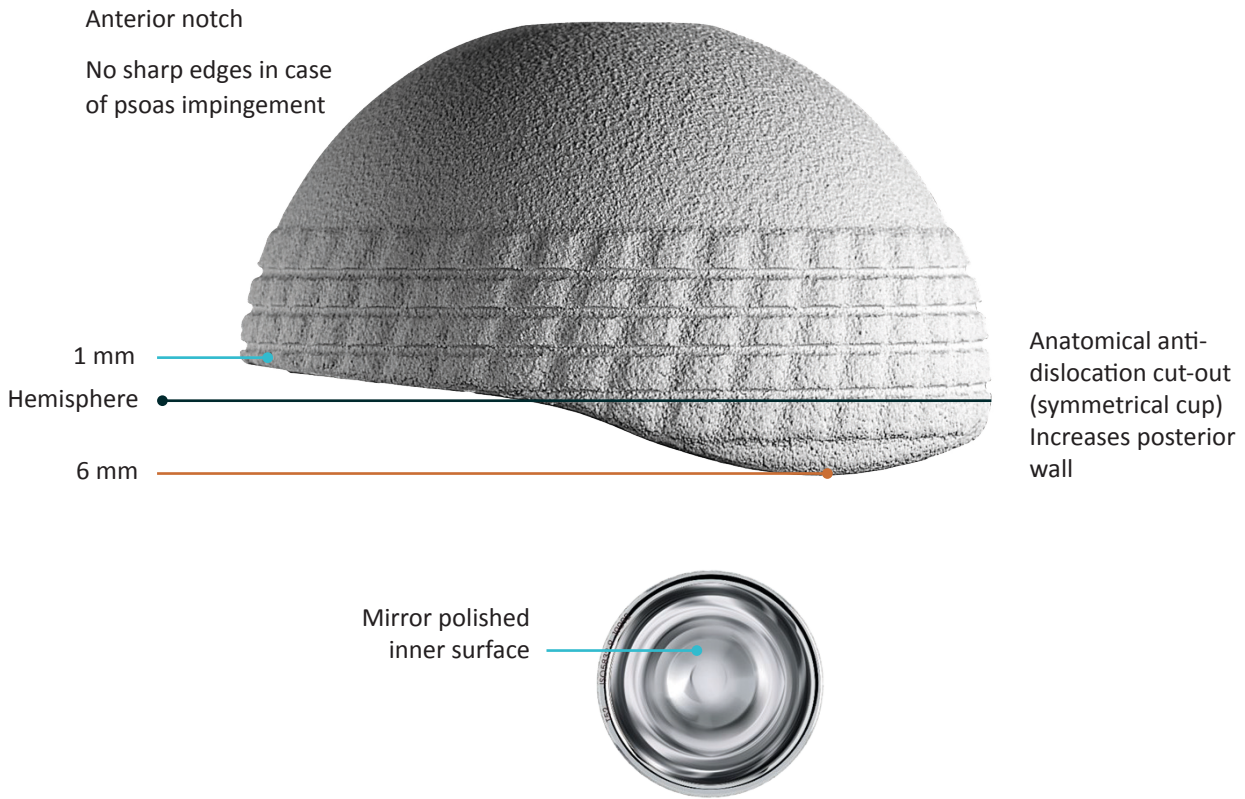

Polyethylene liners

Liners can be paired with $\varnothing 22.2$ mm or $\varnothing 28$ mm femoral heads.

Same design and range for UHMWPE and A.X.P.^E liners.

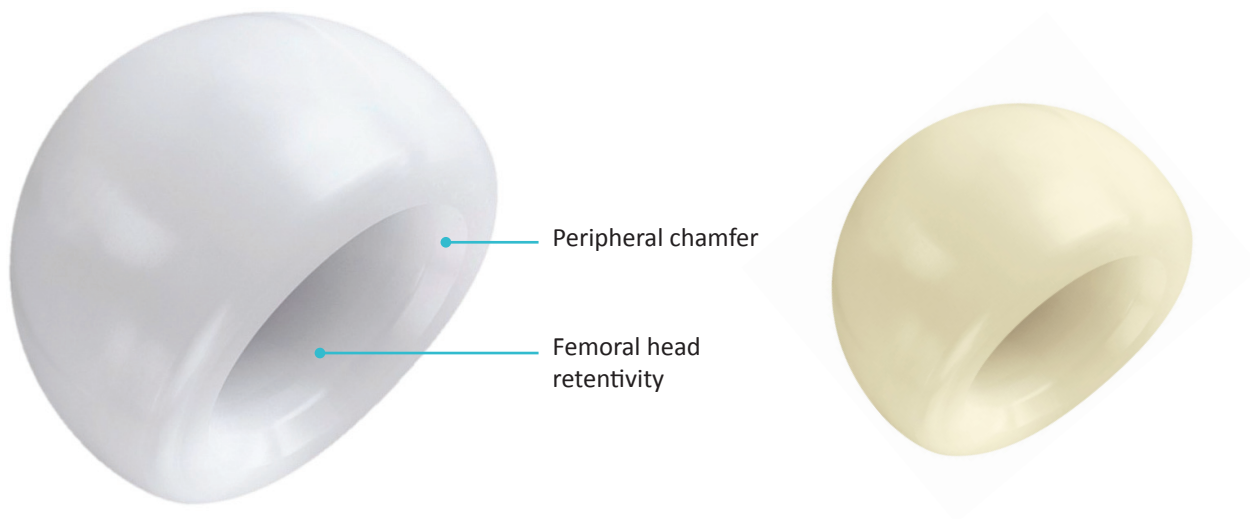

Material: UHMWPE or highly cross-linked polyethylene with vitamin E (A.X.P.^E)

Surgical Technique overview

1

Pre-operative planning

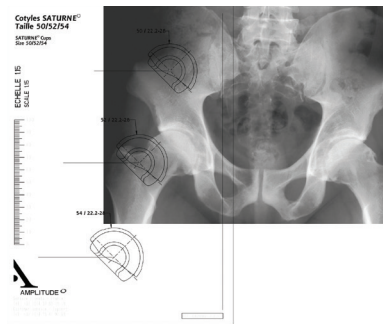

2

Acetabulum reaming



3

Reaming control

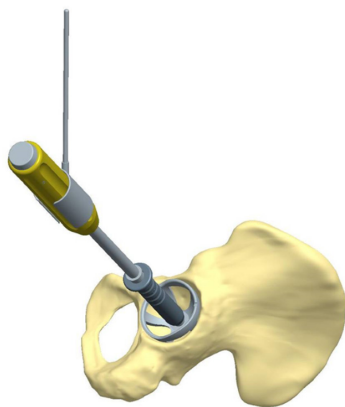

4

Holding the cup

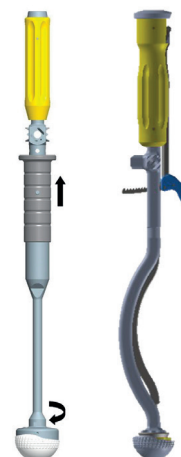

Surgical Technique overview

5 Final cup impaction

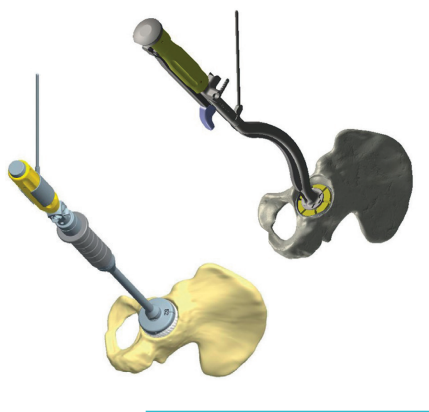

6 Trials with trial liner (optional)

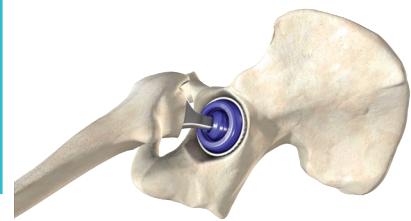

7 Head impaction in the liner

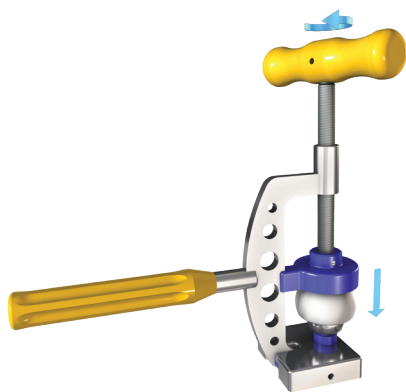

8 Final implant reduction

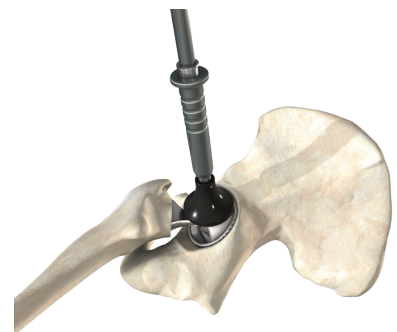

1 Pre-operative planning

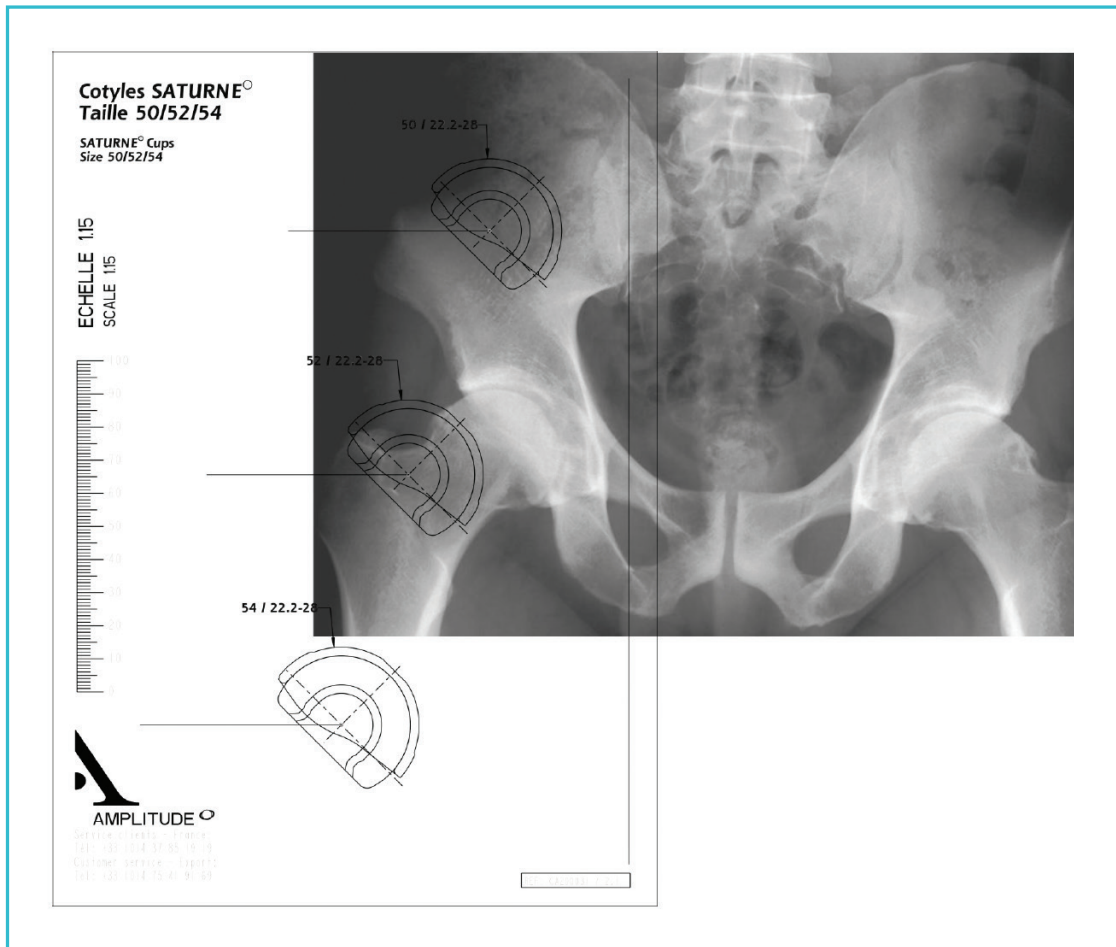

Using the x-rays and templates:

- Determine the joint centre
- Identify the depth of the acetabulum
- Assess the position of the cup
- Determine the cup size

REMINDER

The purpose of this surgical technique description is to provide instructions on how to use the instrumentation properly. The surgeon is fully responsible for choosing and performing the approach and surgical technique.

NOTE

Templates are provided at a 115% scale and can be provided with other scaling on request or in digital format.

2 Acetabulum reaming



Remove any peripheral osteophytes and resect the labrum. Make sure to remove any posterior and inferior osteophytes that could hinder cup placement.

Prepare the acetabulum using the reamers starting with the smallest acetabular reamer available. The reamers can be used with either a straight or offset reamer handle.

Gradually increase the reamer diameter until good peripheral support is achieved and bleeding subchondral bone has been exposed. Make sure not to go past the acetabular fossa (external lamina). The reamed cavity must be completely circular.

Clean out the bottom of the acetabulum, making sure to remove any bone fragments that could interfere with placement of the trial cup.

NOTE

The acetabular reamers size range covers all trial cups and implants. Depending on the adequation between the trial cup and reamed cavity, the reaming step might need to be performed again (see next page).

3 Reaming control

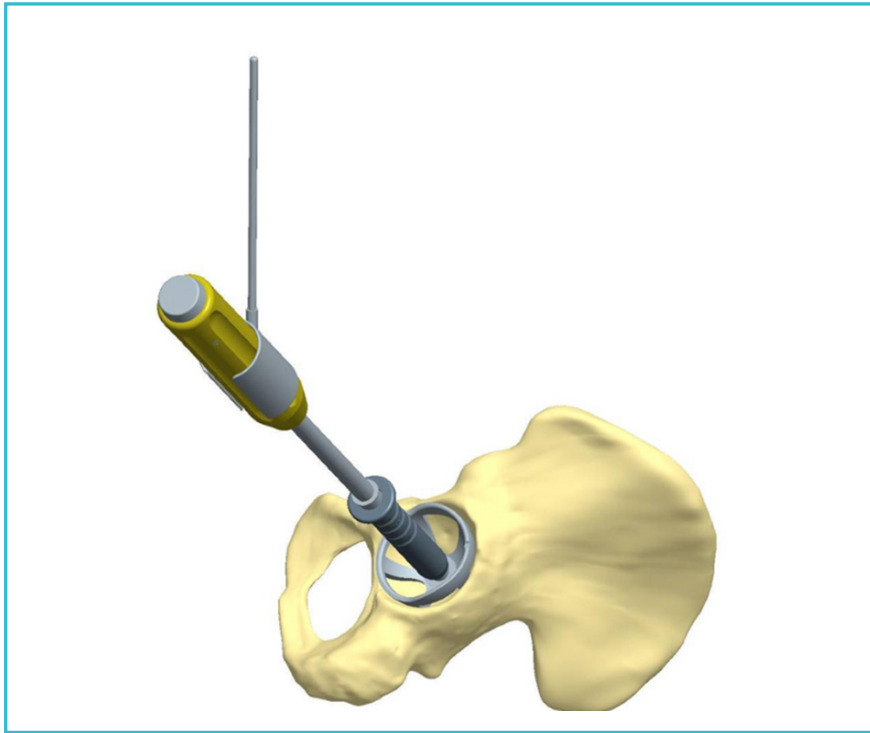

Assemble a trial cup on the universal handle. The chosen size must be based on the last reamer used (see next page). The trial has the same dimensions as the implant, without press-fit. The cup orientor can be placed on the impactor handle to set a 45° angle relative to the vertical plane.

Clean out the bottom and rim of the acetabulum to prevent small bone or tissue fragments from interfering with cup impaction.

Introduce the trial cup while maintaining the inclination and anteversion providing the best bone coverage. The cup is typically placed at 45° inclination and 10° to 15° anteversion, depending on the patient. It must make contact with the entire perimeter of the acetabulum and be **stable** without protruding.

The notch on the top of the trial cup must be positioned in the axis of the obturator foramen and across from it (180°). When the cup diameter and position are validated, make a bony landmark on the acetabulum (with the electric scalpel), aligned with the notch. Since the final implant has the same shape as the trial, this landmark will allow good reproduction of orientation.

Remove the trial cup when reaming is validated.

NOTE

If the trial cup must be impacted (due to sclerotic or hard bone), it is recommended to **adjust acetabular cavity** reaming, following instructions available next page. In every case, reaming is validated based on the trial cup stability.

NOTE

When performing trials, the handle can be removed to leave only the trial cup in the acetabulum.

Reaming technique

Decision tree

Reaming must be performed using even reamers, by size increment (2 mm). The size of the last validated reamer (see p.11) determines the size of the trial cup. The size is validated if the trial is stable in the acetabulum, and introduced without need of impaction. If the trial must be impacted, the following techniques can be followed:

- Ream the equator of the acetabulum one size over (2 mm),
- Ream the whole acetabulum half a size over (1 mm): those reamers are available on request only.

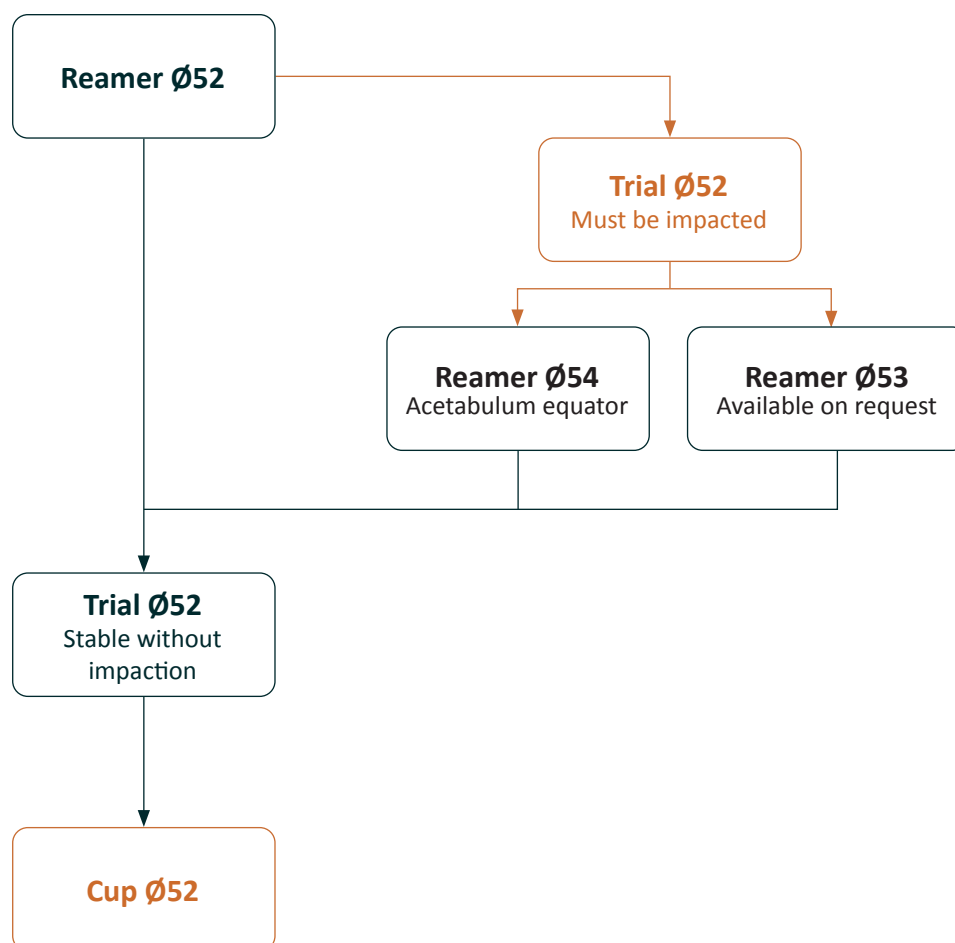

**GENERAL IMPLANT SIZE
RECOMMANDATION :**
 \emptyset trial cup = \emptyset final cup

4 Holding the cup

Final cup

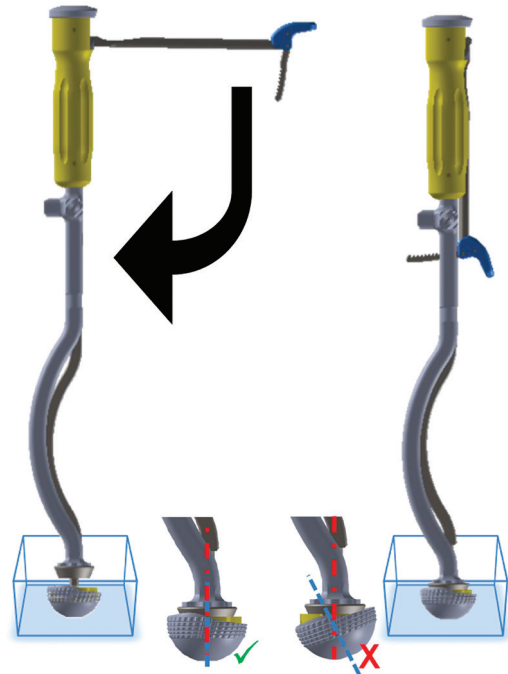
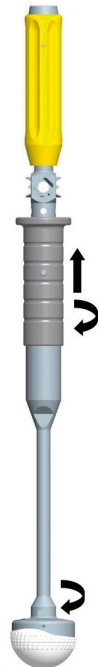

Select the size of the final cup:

- For a **cementless cup**: size **identical** to the trial cup.
- For a **cemented cup**: size **identical or inferior** to the trial cup.

Assemble the impactor being used (« vacuum » of « ratchet » impactor) following instructions available in Annex A and B.

« Vacuum » impactor

Take the final cup out of its packaging and place it on the impaction tip aligning the laser mark at the top of the cup with the groove at the top of the impaction tip.

SATURNE® cementless

Tighten the impaction tip until a good resistance is achieved.

SATURNE® cemented

Slightly tighten the impaction tip, in order to be able to easily remove the impactor without moving the cup.

Engage the vacuum system by putting the handle in «LOCK» position (pull the slider, rotate 1/4)

« Ratchet » impactor

The SATURNE cup still in its packaging, position the impaction tip in the cup with the rod still opened, by aligning the laser mark at the top of the cup with the laser mark at the top of the impaction handle.

Make sure the axis of the cup (blue axis on the illustration) is aligned with the axis of the handle (red axis on the illustration).

Close the rod **until the last notch** to secure the cup prehension.

5 Final cup impaction

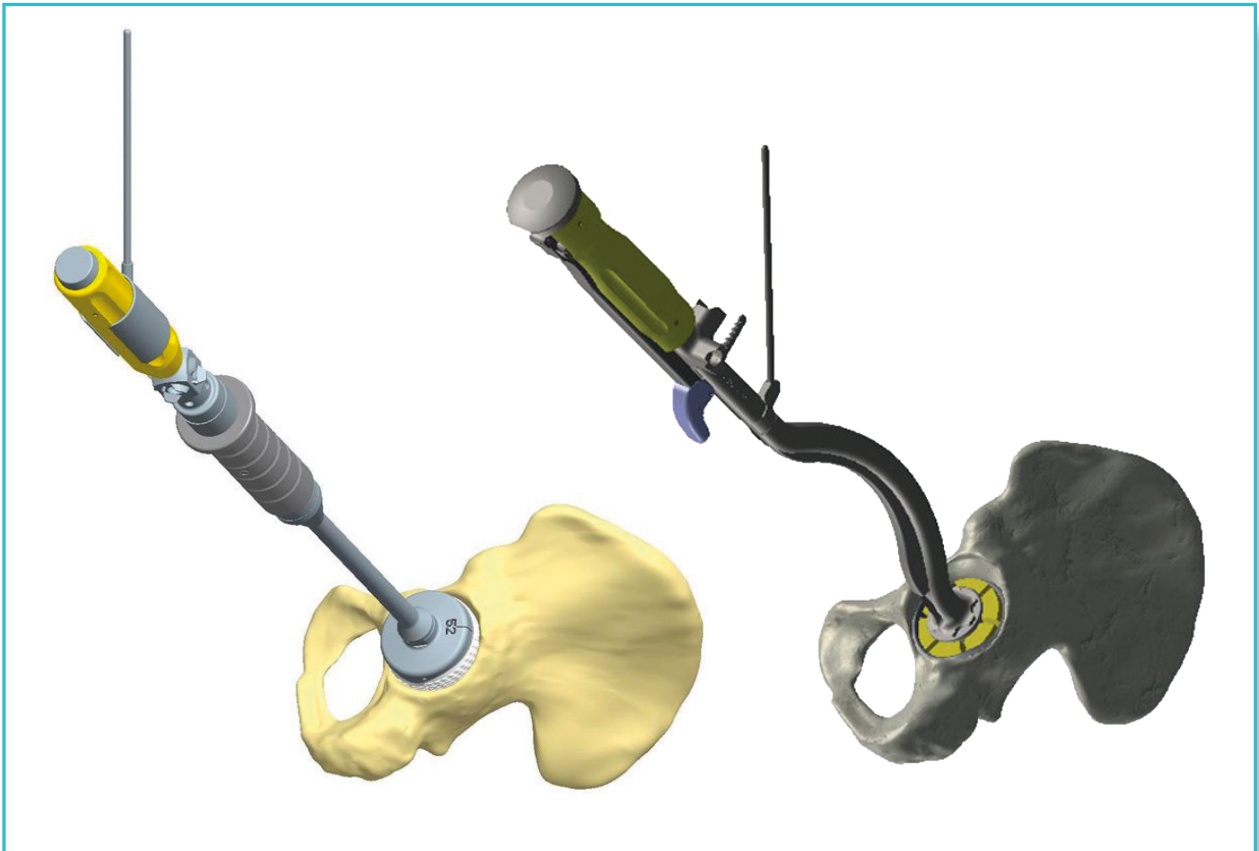

Place the alignment guide on the impactor handle, according to the version being used.

Place the chosen cup in the reamed acetabulum at the predefined inclination and anteversion, and then impact it.

A laser mark on the cup helps reproduce the good orientation of the cup by aligning it with the landmark made during trials.

5 Instrument removal

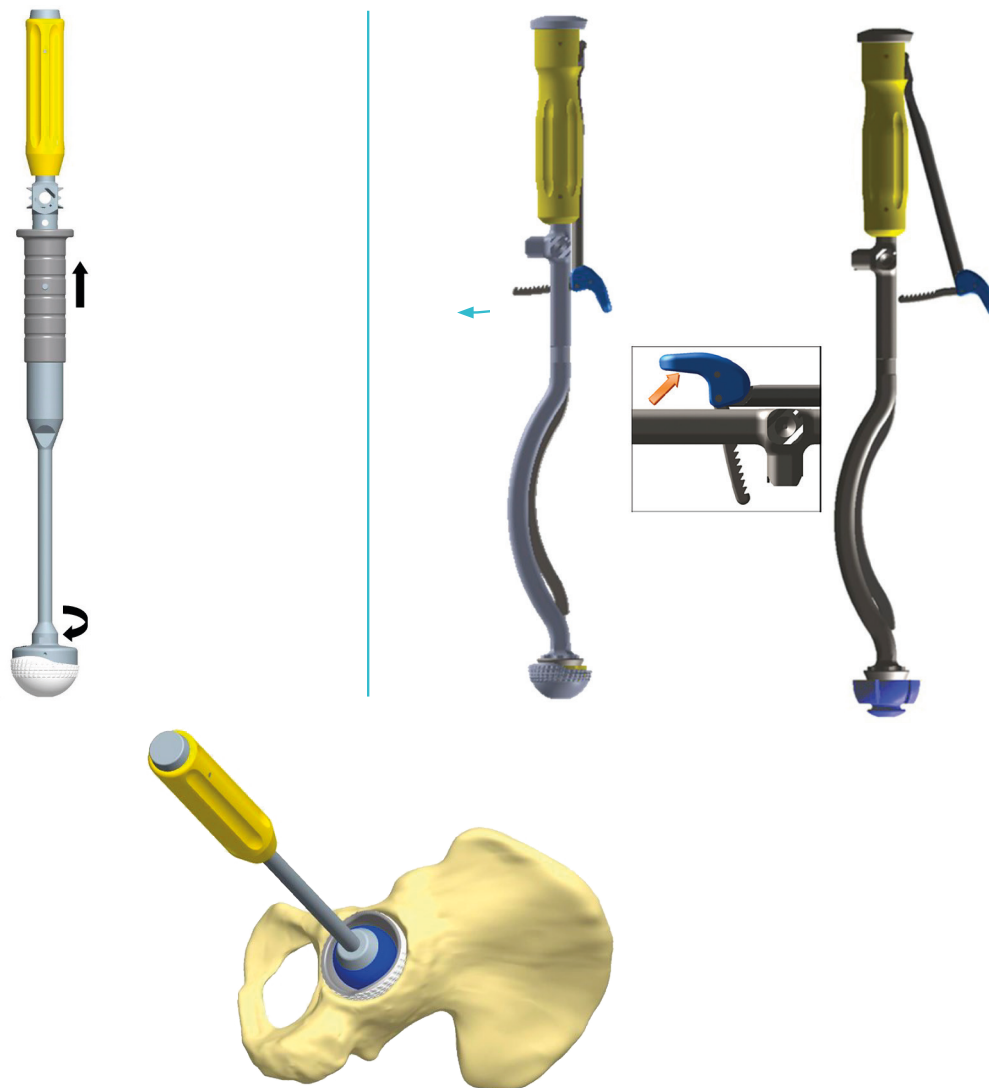

When the cup is perfectly impacted, remove the impaction handle, depending of the model being used:

With the « Vacuum » impactor

Start to untighten the handle and place the slider in the « UNLOCK » position », then remove the instrument.

With the « Ratchet » impactor

Lift the blue button and open the handle to allow removal of the impactor.

NOTE

If necessary, finalize impaction of the cup and reorient it using the final cup impactor.

6 Trials with trial liner (optional)

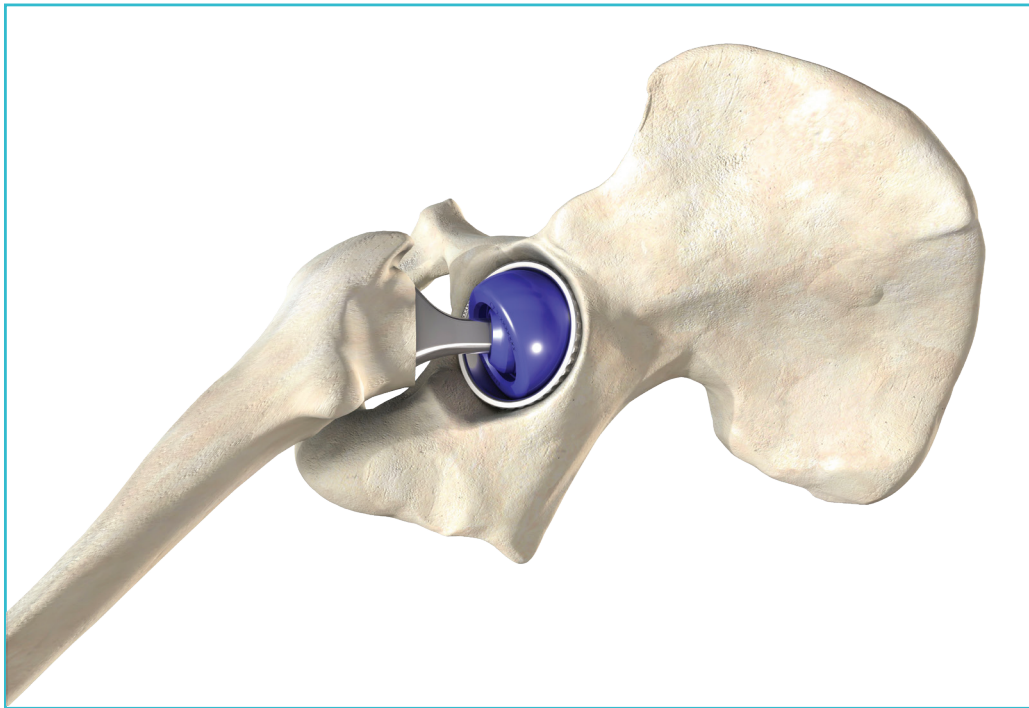

Perform femoral preparation following the implants dedicated surgical technique.

Select the trial liner for dual mobility of the same size as the final cup, and matching the desired femoral head size.

Trial heads and liners color code



Ø22.2mm



Ø28mm

Trial heads neck length code*

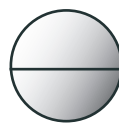

Short
neck

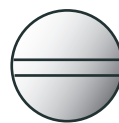

Medium
neck



Long
neck



Extra-long
neck

Perform mobility and stability trials with the femoral stem in place.

Remove trial components when stability is validated.

**Indications, contraindications and pairing restrictions are described in the IFU available with the femoral heads. Please read carefully.*

7 Head impaction in the liner

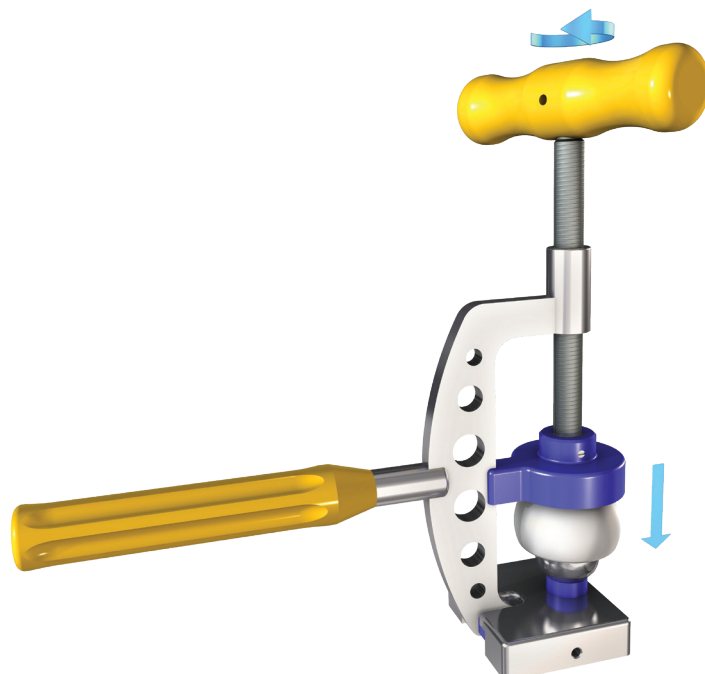
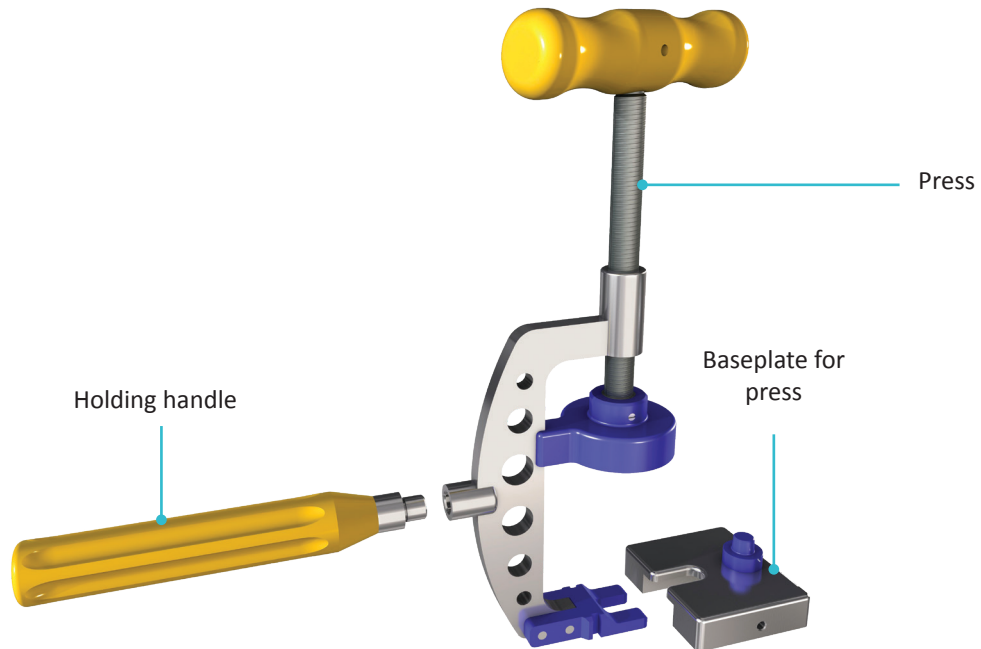

Secure the handle and the baseplate on the dual mobility cup press. Fully loosen the yellow T-handle.

Place a femoral head of the size chosen during the trials on the baseplate.

Select the liner that matches the size chosen during the trials. Place the liner on the head and turn the T-handle on the press until the liner's retaining mechanism has been cleared. An audible noise indicates that the head has moved into the liner and is correctly seated. Turn the T-handle one or two more times to eliminate any air caught in the liner.

Make sure the head can move within the liner.

8 Final implant reduction

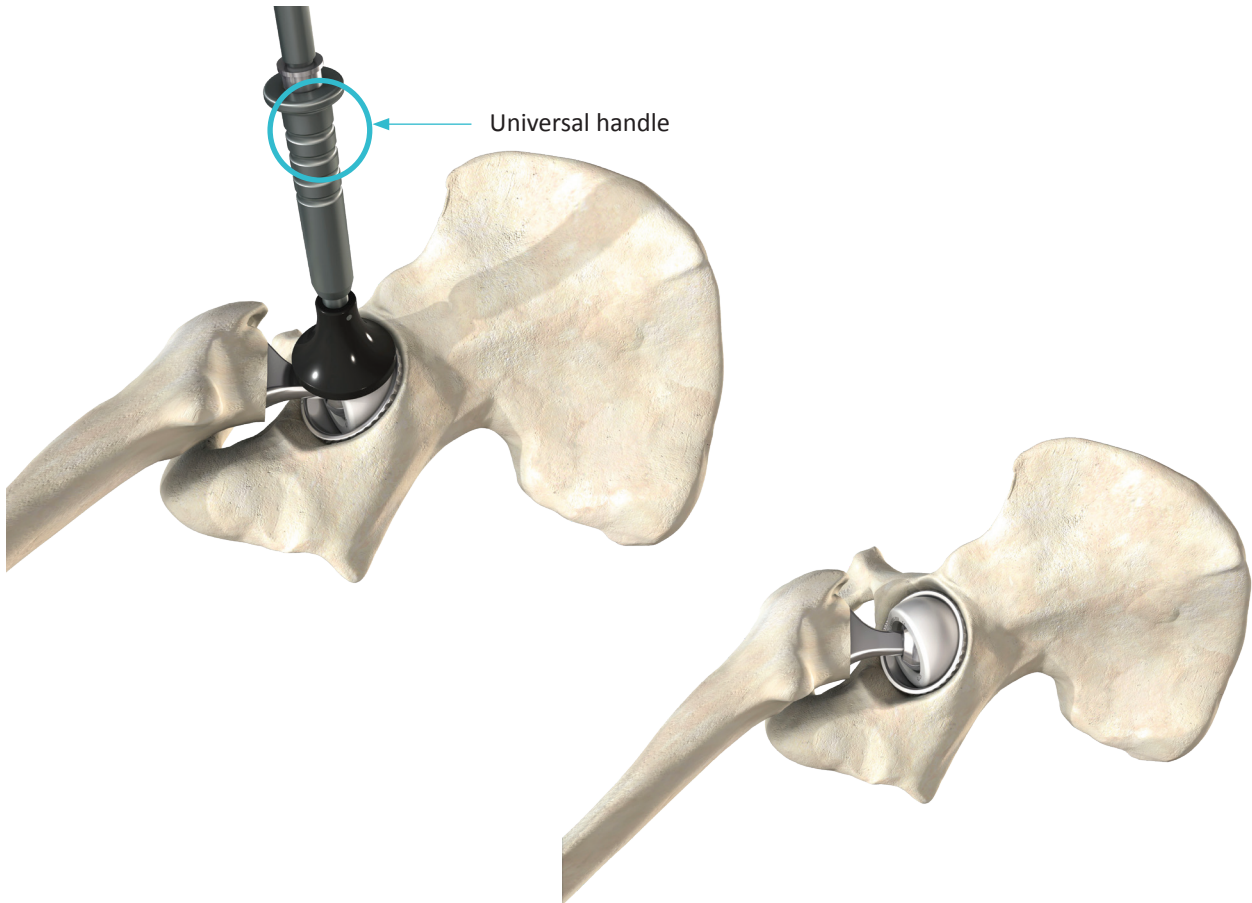

Place the femoral head and liner on the stem taper; impact and reduce it using the liner impaction tip assembled on the universal handle.

Reduce the implants into the implanted cup.

NOTE

Make sure there are no foreign bodies between the liner and cup during the reduction step.

SATURNE reconstruction

Perform preoperative planning using x-rays and templates. Acetabular preparation (reaming) and size validation of the cup (trials with trial cups) will be done the same way as SATURNE cementless and SATURNE cemented cups (see pages 11, 12 & 13).

Before impaction, it is possible to adjust flanges orientation of the SATURNE Reconstruction cup, so they rest against the roof of the acetabulum. A flange bender is included in the instrumentation set for this purpose.

NOTE

The flanges on the SATURNE Reconstruction cup can be bent $\pm 20^\circ$ using the flange bender or can be removed completely if desired. However the hook must not be bent or removed.

Assemble the final cup on the impaction handle following steps described for SATURNE cementless (pages 14 & 15).

Position the final cup in the acetabulum making sure the hook is positioned at the top of the obturator foramen. Then, impact the cup in the acetabulum.

Remove the instrumentation and finalize impaction with the final impactor.

Secure the SATURNE reconstruction cup fixation using $\varnothing 4,5$ mm cortical screws* (not provided).

Impact the femoral head in the liner following steps described page 17.

Position the femoral head with the liner onto the stem taper, impact and reduce the joint using the liner impaction tip assembled on the universal handle.

NOTE

Make sure there are no foreign bodies between the liner and cup during the reduction step.

**Specifications of screws compatible with the device are indicated if the IFU available with the cup.*

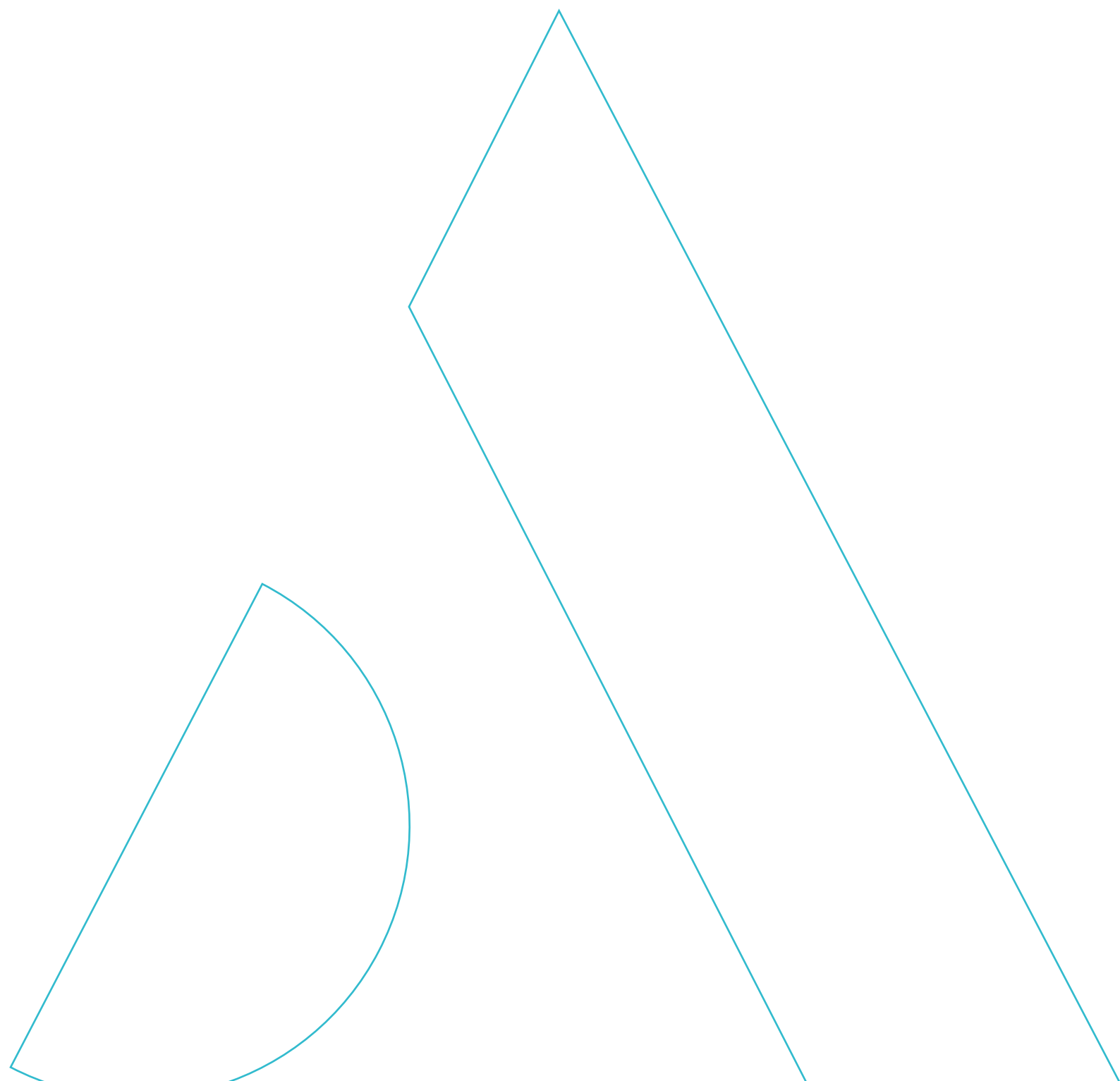

Instrumentation

«Ratchet» curved impactor

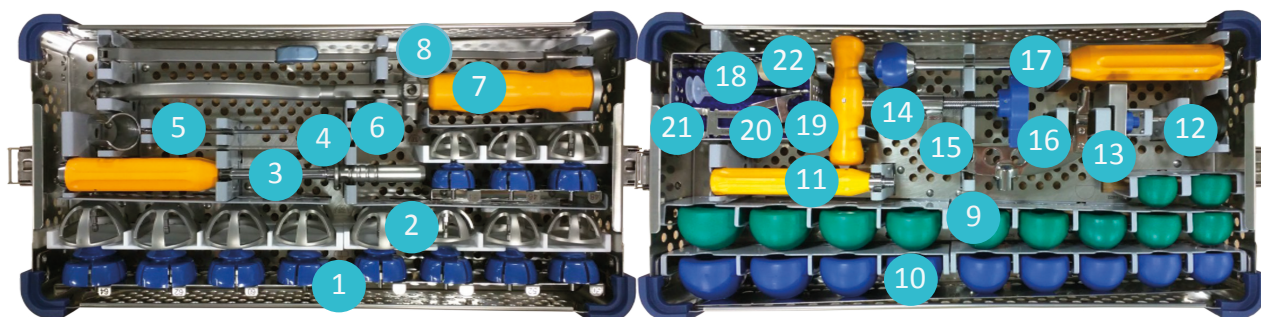

| Rep | Designation | Reference | Qty |
|-----|---|---|--------|
| 1 | SATURNE cup impaction tip Sizes 44 to 64 | 2-01995 44 to 2-01995 64 | 1 each |
| 2 | Trial dual mobility cup Sizes 44 to 64 | 2-01058 44 to 2-01058 64 | 1 each |
| 3 | Universal Handle | 2-0101000 | 1 |
| 4 | Cup alignment guide for impactor handle \varnothing 15 | 2-0126000 | 1 |
| 5 | Cup alignment guide | 2-0102000 | 1 |
| 6 | Conical plate for SATURNE cup impactor | 2-0125300 | 1 |
| 7 | Curved cup impactor - Conventional / Navigated | 2-0199600 | 1 |
| 8 | Rod for SATURNE Curved cup impactor | 2-0125500 | 1 |
| 9 | Trial liner for dual mobility cup Sizes 44/22 to 64/22 | 2-01056 44 to 2-01056 64 | 1 each |
| 10 | Trial liner for dual mobility cup Sizes 48/28 to 64/28 | 2-01057 48 to 2-01057 64 | 1 each |
| 11 | Holding handle | 2-0104200 | 1 |
| 12 | Tip for Dual Mobility Liner Reduction | 2-0107000 | 1 |
| 13 | Base for dual mobility press | 2-0106100 | 1 |
| 14 | Press for dual mobility cup | 2-0105900 | 1 |
| 15 | AMPLITUDE tip for dual mobility press | 2-0106000 | 1 |
| 16 | M5 shoulder screw Lg 16 mm | 4-0110500 | 2 |
| 17 | Final impactor for dual mobility cup | 2-0111400 | 1 |
| 18 | Liner impactor/extractor | 2-0107600 | 1 |
| 19 | H3 hex tip for universal wrench | 2-0106400 | 1 |
| 20 | INITIALE fork for dual mobility press | 2-0112400 | 1 |
| 21 | 12/14 tip for dual mobility press | 2-0113100 | 1 |
| 22 | Cup realignment tip | 2-0115300 | 1 |

Instrumentation

«Ratchet» straight impactor

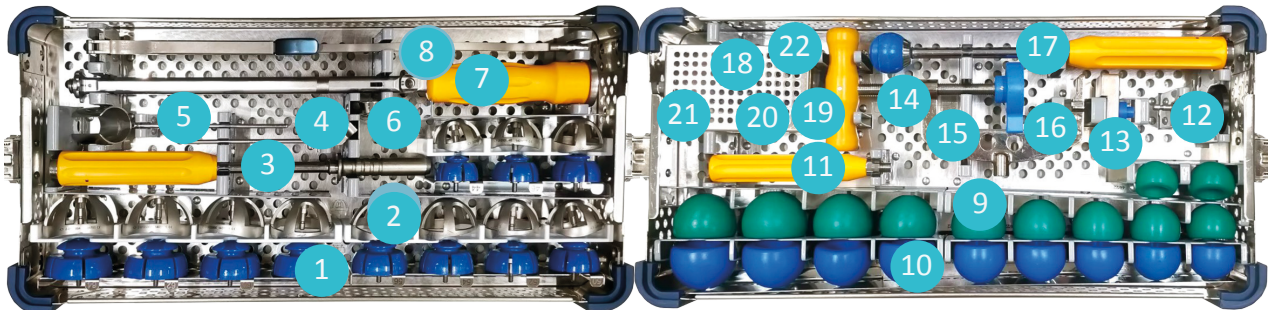

| Rep | Designation | Reference | Qty |
|-----|---|---|--------|
| 1 | SATURNE cup impaction tip Sizes 44 to 64 | 2-01995 44 to 2-01995 64 | 1 each |
| 2 | Trial dual mobility cup Sizes 44 to 64 | 2-01058 44 to 2-01058 64 | 1 each |
| 3 | Universal Handle | 2-0101000 | 1 |
| 4 | Cup alignment guide for impactor handle Ø 15 | 2-0126000 | 1 |
| 5 | Cup alignment guide | 2-0102000 | 1 |
| 6 | Conical plate for SATURNE cup impactor | 2-0125300 | 1 |
| 7 | Straight cup impactor - Conventional / Navigated | 2-0199700 | 1 |
| 8 | Rod for SATURNE Straight cup impactor | 2-0125900 | 1 |
| 9 | Trial liner for dual mobility cup Sizes 44/22 to 64/22 | 2-01056 44 to 2-01056 64 | 1 each |
| 10 | Trial liner for dual mobility cup Sizes 48/28 to 64/28 | 2-01057 48 to 2-01057 64 | 1 each |
| 11 | Holding handle | 2-0104200 | 1 |
| 12 | Tip for Dual Mobility Liner Reduction | 2-0107000 | 1 |
| 13 | Base for dual mobility press | 2-0106100 | 1 |
| 14 | Press for dual mobility cup | 2-0105900 | 1 |
| 15 | AMPLITUDE tip for dual mobility press | 2-0106000 | 1 |
| 16 | M5 shoulder screw Lg 16 mm | 4-0110500 | 2 |
| 17 | Final impactor for dual mobility cup | 2-0111400 | 1 |
| 18 | Liner impactor/extractor | 2-0107600 | 1 |
| 19 | H3 hex tip for universal wrench | 2-0106400 | 1 |
| 20 | INITIALE fork for dual mobility press | 2-0112400 | 1 |
| 21 | 12/14 tip for dual mobility press | 2-0113100 | 1 |
| 22 | Cup realignment tip | 2-0115300 | 1 |

Instrumentation

«Vacuum» impactor



14
15
Outside the trays

| Rep | Designation | Reference | Qty |
|-----|--|---|-------------|
| 1 | Trial dual mobility cup Sizes 44 to 64 | 2-01058 44 to 2-01058 64 | 1 each |
| 2 | Universal Handle | 2-0101000 | 1 |
| 3 | Cup alignment guide | 2-0102000 | 1 |
| 4 | Dual mobility cup handle/impactor Sizes 44 to 64 | 2-01910 44 to 2-01910 64 | 1 each |
| 5 | Extension for dual mobility cup impactor - Navigated | 2-0191100 | 1 |
| 6 | Pump impactor for dual mobility cup | 2-0107700 | 1 |
| 7 | Dual mobility cup impactor handle - conventional / navigated | 2-0192100 | 1 |
| 8 | Trial liner for dual mobility cup Sizes 44/22 to 64/22 | 2-01056 44 to 2-01056 64 | 1 each |
| 8 | Trial liner for dual mobility cup Sizes 48/28 to 64/28 | 2-01057 48 to 2-01057 64 | 1 each |
| 9 | Press for dual mobility cup AMPLITUDE tip for dual mobility press M5 shoulder screw Lg 16 mm | 2-0105900 2-0106000 4-0110500 | 1 1 2 |
| 10 | Holding handle | 2-0104200 | 1 |
| 11 | Base for dual mobility press | 2-0106100 | 1 |
| 12 | Tip for Dual Mobility Liner Reduction | 2-0107000 | 1 |
| 13 | Liner impactor/extractor | 2-0107600 | 1 |
| 14 | Final impactor for dual mobility cup | 2-0111400 | 1 |
| 15 | Tibial stem wrench | 2-0205500 | 1 |

Instrumentation

SATURNE® reconstruction additional tray



| Rep | Designation | Reference | Qty |
|-----|--|------------|-----|
| 1 | Acetabular reamer Ø66 | MFR3100661 | 1 |
| 2 | Trial dual mobility cup Size 66 | 2-0105866 | 1 |
| 3 | Dual mobility cup handle/impactor Size 66 | 2-0191066 | 1 |
| 4 | Trial liner for dual mobility cup Size 66/22 | 2-0105666 | 1 |
| 5 | Trial liner for dual mobility cup Size 66/28 | 2-0105766 | 1 |
| 6 | Flange bender | 2-0108900 | 1 |
| 7 | SATURNE cup impaction tip Size 66 | 2-0199566 | 1 |

Instrumentation

Acetabular reamers set

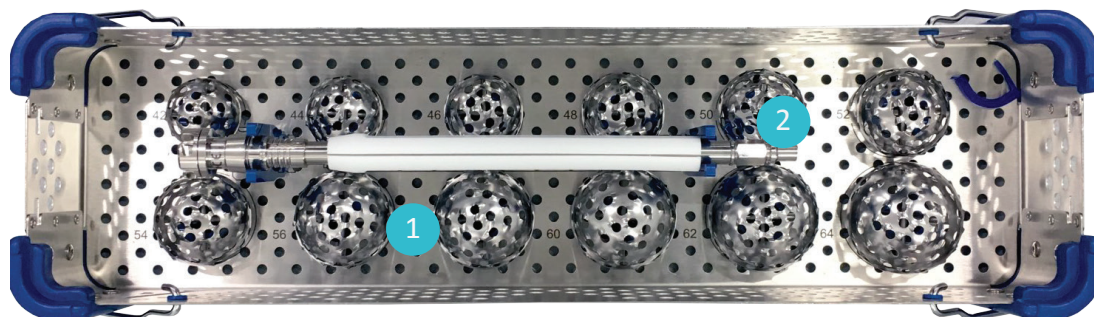

| Rep | Designation | Reference | Qty |
|-----|--|---------------------------|--------|
| 1 | Acetabular reamer $\varnothing 42$ to $\varnothing 64$ | 2-0192942 to 2-0192964 | 1 each |
| 2 | Complete monobloc reamer holder with AO connection | MPF310030 | 1 |

Acetabular reamers set - odd sizes



| Rep | Designation | Reference | Qty |
|-----|--|---------------------------|--------|
| 1 | Acetabular reamer $\varnothing 41$ to $\varnothing 65$ | 2-0192941 to 2-0192965 | 1 each |
| 2 | Straight Reamer Handle - AO coupling | T17780* | 1 |

*optional if the tray of even sizes reamers has already been provided.



| Description | Reference |
|-----------------------------------|-----------|
| IMA reamer handle - Metallic - AO | 50244501 |



| Description | Reference |
|---------------------------------|-----------|
| IMA reamer handle - carbon - AO | T17875 |



Annex A

« Vacuum » impactor assembly instructions

- 1 Assemble the pump on the handle.

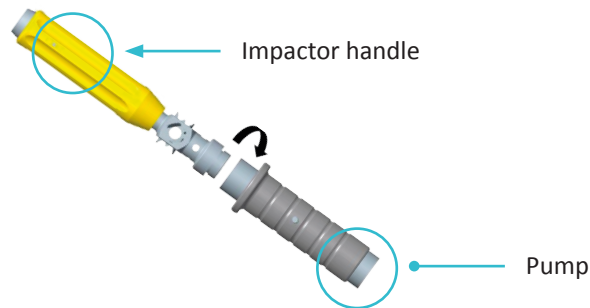

- 2 Tighten the assembly to the extension.

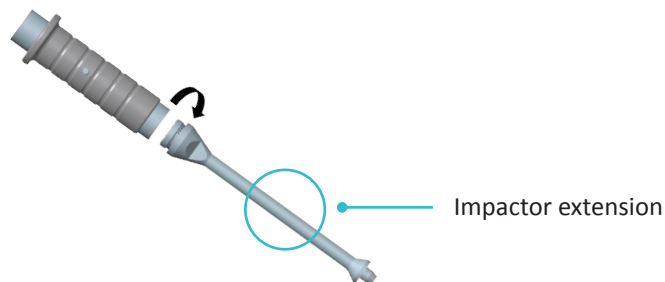

- 3 **Partially** Iscrew the cup impactor, of the same size as the final cup. The final tightening of this part must be done **after** placing the implant on it, and depending on the cup model being use (see p.14 for more instructions).

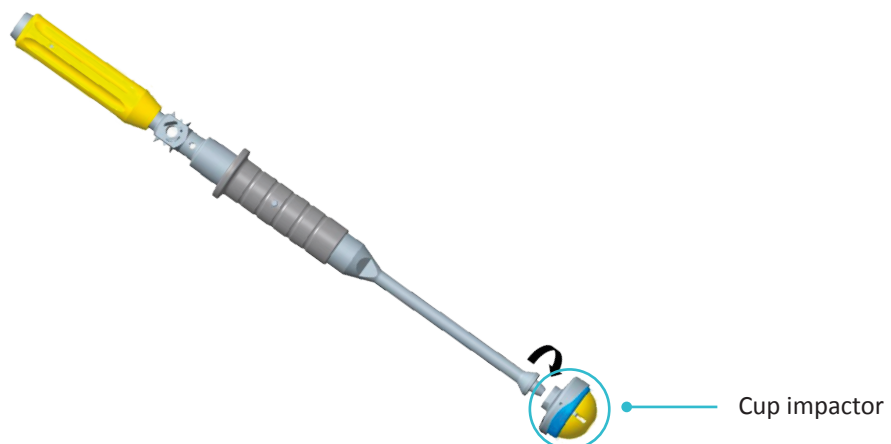

Annex B

« Ratchet » impactor assembly instructions

- 1 Place the proximal part of the rod into the impactor handle.

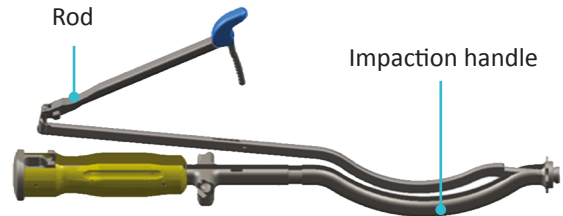

- 2 Position the rod in the rail while making sure the guide pin is correctly seated in the rod.

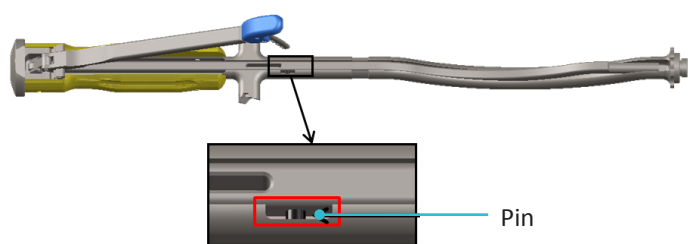

- 3 Position the rod's metal handle in the fork; the proper position is shown inside the green circle: the axle is fully seated in the rounded recess.

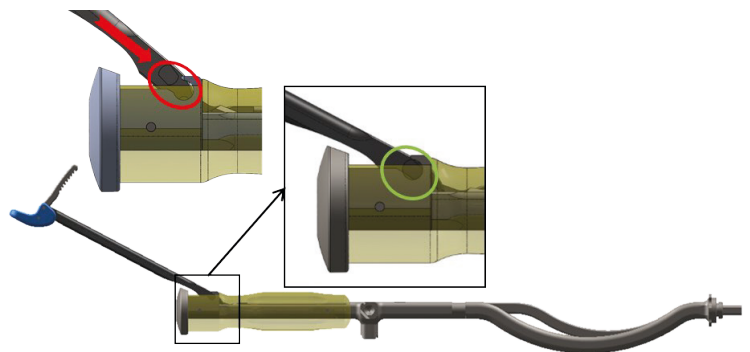

- 4 Screw the conical plate (widest part toward the handle) for SATURNE impactor (screw until fully tightened)



- 5 Rod opened, assemble the impaction tip of the same size as the implant, until fully tightened



Annex C

Composition of SATURNE impactors for "Vacuum" im- pactor

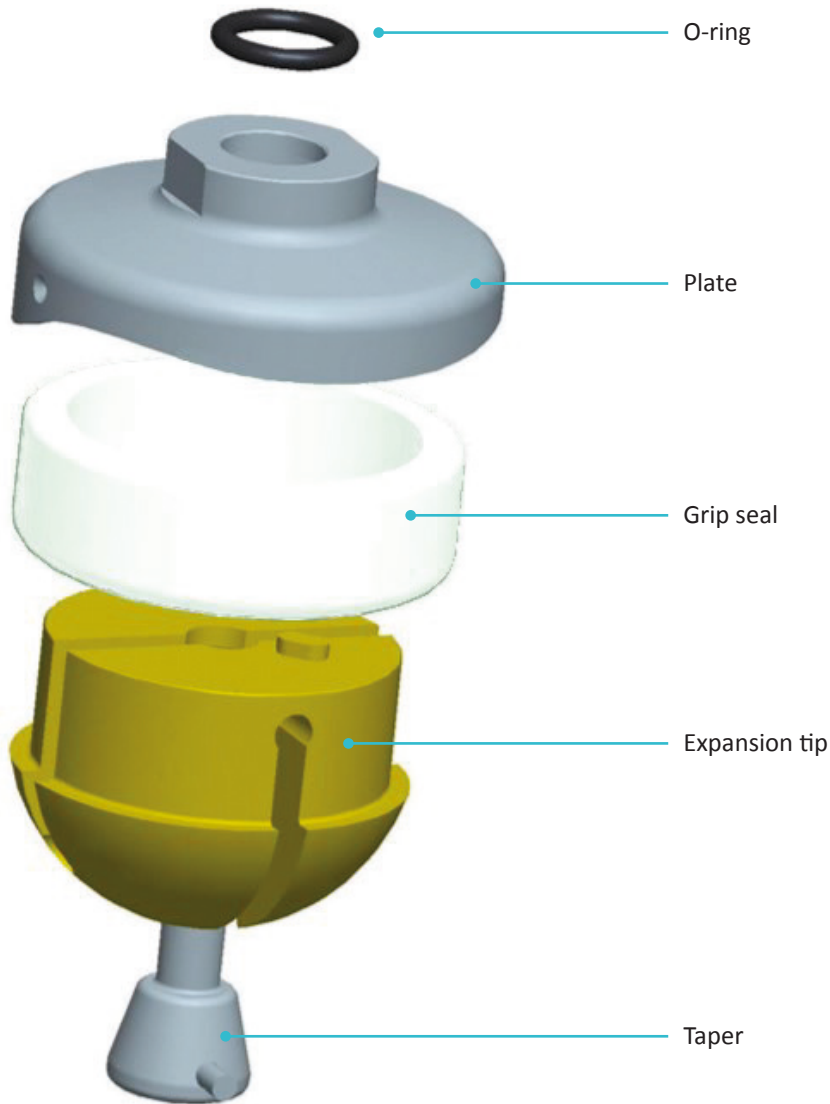

The plate and the expansion tip must be of the same size (check engraving on the instruments). The expansion tip must be correctly oriented compared to the plate : the peg of the expansion tip must fit inside the slot in the plate.

NOTE

The grip seal is transparent.

NOTES

NOTES



NOTES

NOTES







Products availability may vary depending on countries. Please check availability with your local representative.

Service Clients – France :

Porte du Grand Lyon,
01700 Neyron – France
Tél. : **+33 (0)4 37 85 19 19**
Fax : +33 (0)4 37 85 19 18
E-mail : amplitude@amplitude-ortho.com

Customer Service – Export :

11, cours Jacques Offenbach,
ZA Mozart 2,
26000 Valence – France
Tél. : **+33 (0)4 75 41 87 41**
Fax : +33 (0)4 75 41 87 42

www.amplitude-ortho.com