



# Surgical Technique

4-in-1 Conventional Instrumentation  
with common knee instrumentation



# Table of contents

Introduction .....	4
Overview of the implant .....	5
Overview of the surgical technique .....	12
Pre-operative planning .....	15
Step 1 Distal femoral resection .....	16
Step 2 Intramedullary tibial system.....	19
Step 3 Combined Intramedullary tibial system.....	22
Step 4 Tibial resection .....	24
Step 5 Extension and flexion gaps .....	25
Step 6 Femoral Sizing .....	26
Step 7 4-in-1 Femoral Resection .....	28
Step 8 Femoral preparation .....	29
Step 9 Positioning of the trial femoral component .....	31
Ste 10 Tibial preparation .....	32
Step 11 Patella preparation : patellar resection option .....	34
Patella preparation : Patella reaming option .....	35
Step 12 Definitive implants .....	36
Appendix 1 - Implants extraction.....	38
Appendix 2 - Combined Extramedullary tibial system.....	39
Appendix 3 - Extramedullary tibial system .....	41
Appendix 4 - Ligament balancer .....	43
Instrumentation .....	47

---

# Introduction

- This surgical technique relates to the ANATOMIC instrumentation and the 4-in-1 conventional common knee instrumentation used to implant the ANATOMIC Total Knee System (TKS).
- Either the tibial cut or the distal femoral cut can be performed first.
- In the following surgical technique description, the distal femoral cut is performed first.
- The instrumentation can be used either:
  - without navigation (conventional method)
  - with navigation (by adding the Universal Knee Navigation Tools)
  - with the customised i.M.A.G.E. instrumentation (by adding the i.M.A.G.E. 4-in-1 tools).



---

# Overview of the implant

- The ANATOMIC TKS is a PCL-sacrificing, posterior-stabilized, fixed bearing implant for primary knee arthroplasty.
- Its mediolateral coverage matches the morphology of the femur.
- Stability is provided:
  - in extension thanks to a congruent anterior lip,
  - in flexion thanks to a late contact between the cam and the post of the posterior stabilization mechanism.



# Femoral component



Trochlear groove lateralised by an average of 2.3 mm



Asymmetrical contact surfaces:  
quasi-physiological joint kinematics



Post-cam contact beyond 90 flexion and up to 130° flexion

# Patellar component

Polyethylene patellar implant available in two versions:

**Onset patellar implant—  
cemented**

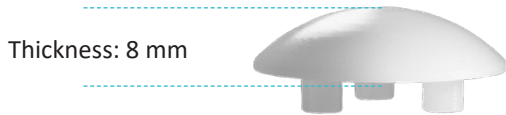

**Inset patellar implant—  
cemented**



# Tibial component

## Tibial insert :



Posterior post position: beneficial for flexion



Flat baseplate posteriorly  
✓ Condyle rollback during flexion

# Tibial component

## Tibial baseplate :

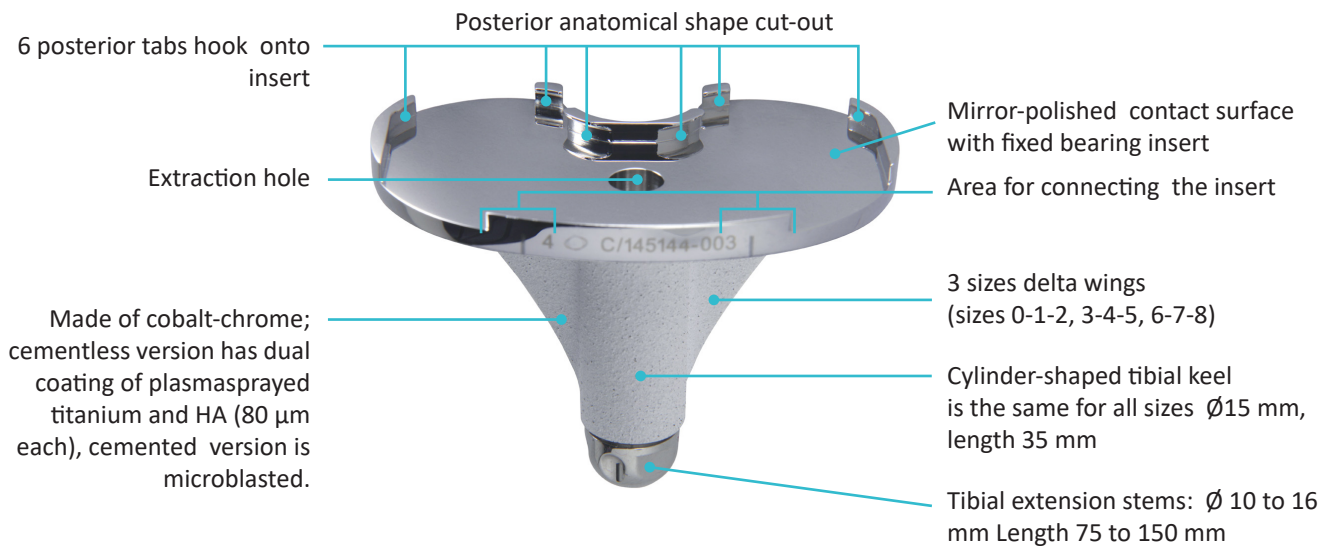

Possibility of using (e.g. in cases of UKA revision or TKA after osteotomy):

### Tibial extension stems :

- Ø 10 to 16 mm
- Length 75 to 150 mm

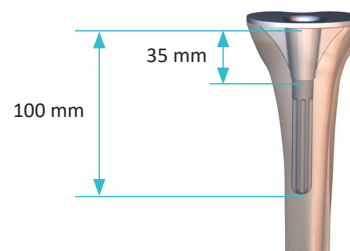

Example with a 100mm long extension stem

Length	Diameter			
	10	12	14	16
75				
100				
150				

### ANATOMIC tibial augments :

- Thickness 5 mm
- Thickness 10 mm
- Thickness 15 mm



# Product range

## Femoral components :

- Cemented: 9 sizes (0 and 8 are optional)
- Cementless: 9 sizes (0 and 8 are optional)

Mediolateral implant coverage matches bone morphology

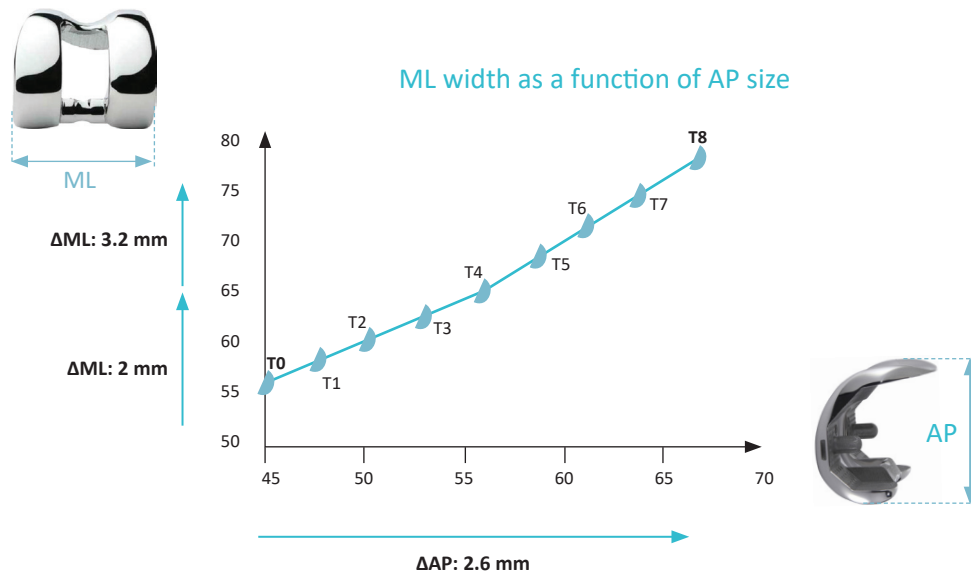

## Patellar components :

- Onset patellar implant – cemented: Ø 30, 33 and 36 mm
- Inset patellar implant – cemented: Ø 23, 26 and 29 mm

## Tibial components :

- Cemented: 9 sizes (0 and 8 are optional)
- Cementless: 9 sizes (0 and 8 are optional)

## Inserts :

- 9 sizes (0 and 8 are optional)
- 6 thicknesses (10, 12, 14, 16, 18 & 20 mm)

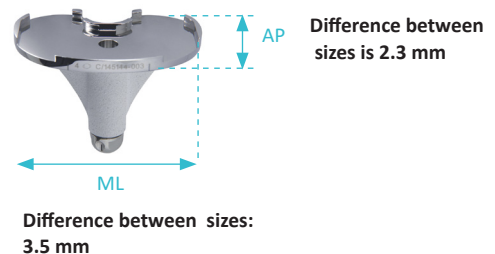

# Components compatibility

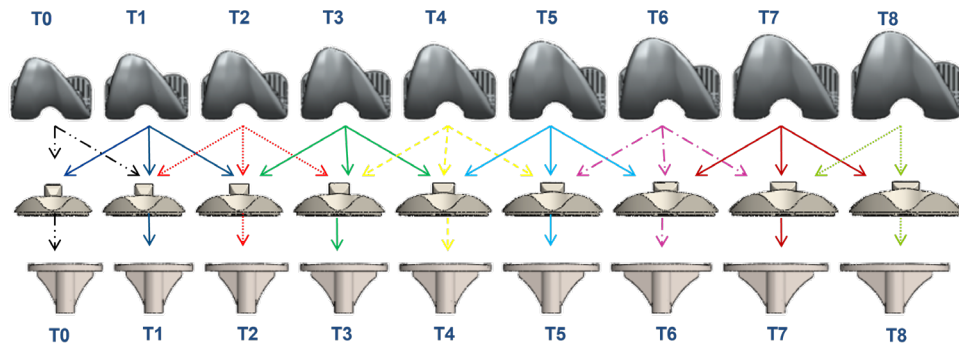

All sizes of cemented resurfacing patellar implants are compatible with all sizes of ANATOMIC posterior stabilized femoral components.

ANATOMIC femoral component size 7 and size 8 are not compatible with cemented inset patellar implant  $\varnothing$  23 mm.

A cemented congruent asymmetric resurfacing patellar implant is also available with the anatomic TKA. The range, compatibility with femoral component and surgical steps are described in the surgical technique TO.G.058.



# Overview of the surgical technique

1

Distal femoral resection



2

Intramedullary tibial system

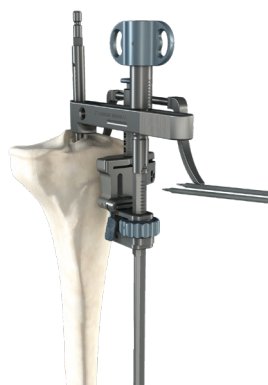

3

Combined Intramedullary tibial system



4

Tibial resection



# Overview of the surgical technique

5

Extension & Flexion Gap Measurement



6

Femoral Sizing

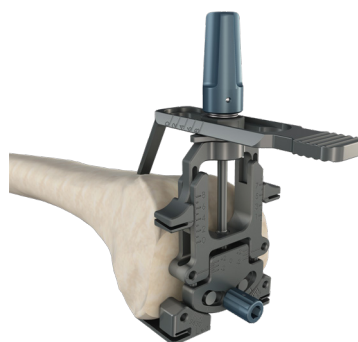

7

4-In-1 Femoral Resection



8

Femoral preparation

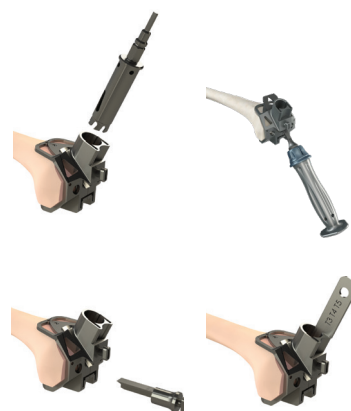

# Overview of the surgical technique

9

Positioning of the trial femoral component



10

Tibial preparation



11

Patella preparation



12

Definitive implants



# Pre-operative planning

Using X rays and templates, you can determine concerning bone:

## On the tibia :

- The choice between intramedullary and extramedullary aiming.
- The entry point of the intramedullary rod (coronal and sagittal view).
- The adaptation of the tibial stem to the metaphysis (in case of previous tibial osteotomy).
- The osteophytes.
- The severity of the compartment wear.
- The choice of an extension tibial stem, if required.
- The assessment of the baseplate size and the insert thickness.

## On the femur :

- The entry point of the intramedullary rod (front and sideways).
- The anatomical femoral valgus angle.
- The posterior osteophytes.
- The size.

## On the patella :

- The wear of the patellofemoral joint.
- The thickness, the width, the global shape, the tilt and the height of the patella.
- The thickness and the orientation of the patellar resection.
- The mediolateral position of the patellar implant.

### NOTE

The provided templates have a 1:1 scale. Make sure the template scale matches the X-ray scale

### REMINDER

This surgical technique describes how to use the instrumentation properly. The surgeon is fully responsible for choosing the surgical approach and technique

# 1 Distal femoral resection



## Intramedullary femoral alignment :

- Bend the knee at 90°
- Remove any peripheral osteophytes.
- Clear out tissues to access the anterior cortex.
- Based on the pre-operative planning, determine the entry point for the intramedullary (IM) canal and open it with the Intramedullary drill bit.
- Assemble the Intramedullary rod length 400 mm on the T wrench, and insert it into the canal. The landmark located on the Rod must always be visible.

### NOTE

If the Intramedullary rod length 400 mm cannot be inserted or if there is a pre-existing THA, use the Intramedullary rod length 250 mm.

## Position the Femoral Valgus Alignment Guide :

- Adjust the Femoral Valgus Alignment Guide 3° according to the side and to the femoral valgus measured during the pre-operative planning.
- Unlock the system by turning the blue screw, adjust the desired value and tighten the screw to secure it.
- Place the Femoral Valgus Alignment Guide on the intramedullary rod.
- Make sure the barrel rests against a healthy portion of the distal condyle and confirm the femoral valgus reading.
- The Valgus Barrel can be secure on the distal part of the femur with 2 Headed Pins length 30 mm insert into the 2 holes located on the Alignment Guide.



### NOTE

If needed a Femoral Valgus Alignment Guide 0° and a Femoral Valgus Alignment Guide 6° are also available as an option with 0° and 6° of Flexion.



# 1 Distal femoral resection



## Position Distal Cutting Guide :

- Assemble the Distal Cutting Block 10 mm – Clip System on the Distal Slider – Clip System until the locking system is insert into the slot of the Distal Cutting Block.

- Insert the assembly on the Femoral Valgus Alignment Guide.
- Attach the Distal Cutting Block on the bone with 2 Threaded non-headed Pins Length 80 mm (options: Length 65 mm or 100 mm) on the 0 holes (1).
- Remove the whole extramedullary system:
  - Assemble the T Wrench on the Intramedullary Rod.
  - Unlock the Distal Slider from the Distal Cutting block by pressing the button.
  - Remove the entire assembly.



### NOTE

If needed a Distal Cutting Block 8 mm – clip system is also available as an option to perform a 8 mm distal resection.

# 1 Distal femoral resection

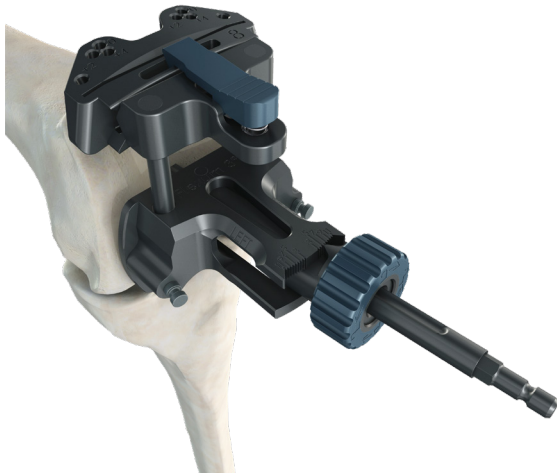

## Perform distal resection :

- Once the Distal Cutting Block is against the bone, check the amount of bone resected with the Resection Gauge inserted in the slot of the guide.
- If necessary, the guide can be shifted by 2 mm: remove the guide by sliding it on the 2 pins, choose the +2 or -2 holes to replace it rest against the bone.
- Secure the Guide with 1 or 2 Collared Threaded Pin  $\varnothing$  3.2 Lg 57 inserted in the oblique holes.

- Perform the distal resection using a medium AMPLITUDE Sawblade.
- Remove the oblique pins.
- Remove the Distal Resection Guide, leaving the 2 pins in case of re-cutting.



### NOTE

Only the Distal Cutting Block 8 mm - Clip System is compatible with the i.M.A.G.E. system

## 2 Intramedullary tibial system

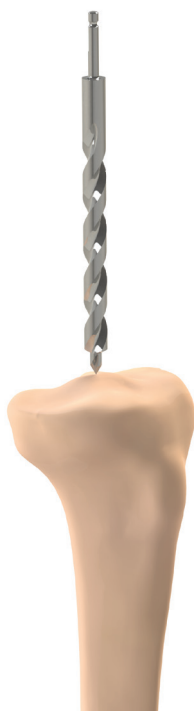

### Locating the medullary canal :

- Place the knee in hyperflexing position and dislocate the tibia forward.
- Based on the pre-operative planning, make a hole in the middle of the medullary canal using the Intramedullary drill bit.

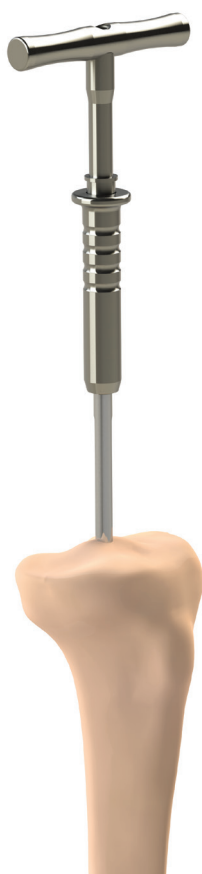

- Assemble the Intramedullary rod length 400 mm on the T wrench and insert it into the canal, the landmark must always be visible.

### NOTE

If the Intramedullary rod length 400 mm cannot be inserted use the Intramedullary rod length 250 mm.

## 2 Intramedullary tibial system

### Intramedullary tibial system assembly :

- Assemble the 4T Wheel/Tibial Resection Guide Support with the 4T Aiming with tibial bracket. ①  
Push the Green wheel until the chosen height.

#### NOTE

The 'UP' engraving corresponds to the 4T Wheel/Tibial Resection Guide Support's superior side

#### NOTE

The 'A' engraving on the 4T Aiming with tibial bracket must be on the anterior side.

- Insert the 4T tibial bracket on the 4T Aiming with tibial bracket ②. Screw the 4T Proximal AP Wheel on the top of the rod ③.
- Insert the Tibial Cutting Block Light 3° (right or Left according to the operated side) on the 4T Wheel/Tibial Resection Guide Support. The value of the posterior slope is marked on top of the guide. ②

③



#### NOTE

The instrumentation set contains two rods. Use the longest one with the 4T tibial bracket.

#### NOTE

The Tibial Cutting Block Light – Right or Left is available with 3° (recommended) posterior slope but also with 0° posterior slope.

#### NOTE

The Tibial Cutting Blocks Light are not compatible with the i.M.A.G.E. system.

## 2 Intramedullary tibial system

### Intramedullary tibial system :

- Insert the assembly onto the Intramedullary Rod - Length 400 mm, adjust its rotation relative to the anterior tibial tuberosity and then impact the tabs.
- Insert the 4T Tibial Stylus 2/10 on the Tibial Cutting Block Light (make sure the clip is fully engaged).
- Set the resection height by using the 4T tibial stylus to palpate either the:
  - healthy side (10 mm cut relative to palpated point)
  - worn side (2 mm cut relative to palpated point/exit of saw blade)



#### IMPORTANT

For other resection heights :

- A coarse adjustment can be done by pushing the green wheel.
- A fine adjustment can be done by screwing the green wheel.

- Check the height of the bone cut with the Resection gauge inserted into the slot.
- Insert 2 Threaded Non-Headed Pins Lg 80mm in the 0 mm holes with the Pin Driver AO (or Hall).

#### NOTE

The 4T tibial stylus can be clipped on the lateral side of the 4T tibial resection guide to palpate the medial plateau (or the reverse) by passing the 4T tibial stylus over the 4T tibial bracket.

### 3 Combined Intramedullary tibial system

#### Combined intramedullary tibial system assembly :

- Screw the 4T Distal AP wheel on the 4T EM Jig ①
- Insert the 4T Rod for bimalleolar clamp for the Malleolar Clamp into the EM 4T EM Jig ②. Lock it in place with the 4T Distal AP wheel ③.

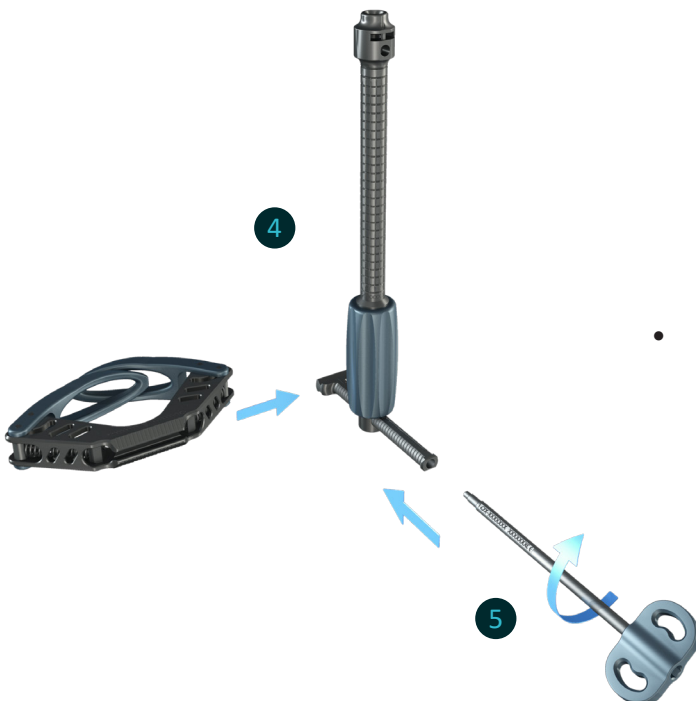
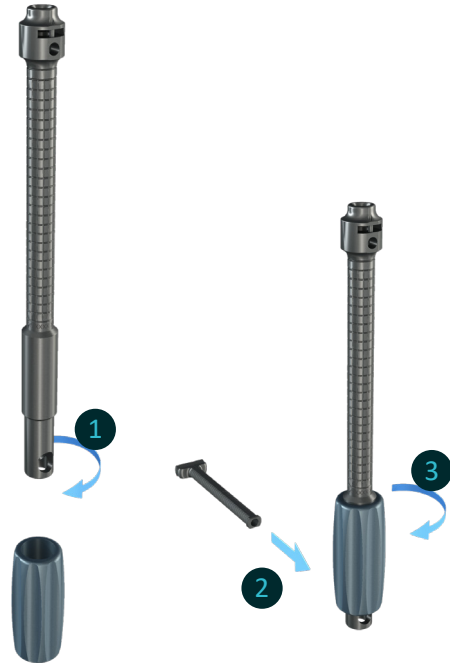

- Assemble the 4T malleolar clamp on the 4T Rod for bimalleolar clamp ④. Lock it in place with the 4T ML wheel for malleolar clamp ⑤.

## 3 Combined Intramedullary tibial system

### Combined intramedullary tibial system :

- Assemble the intramedullary tibial system as described in the paragraph «Intramedullary tibial system assembly» and insert it into the assembly described above. Lock them using the 4T Wheel for EM Jig.
- Place the 4T malleolar clamp around the ankle (the clamp has a self-opening feature that makes it easier to set up), lock the clamp and position the 4T tibial bracket on the Intramedullary rod length 400 mm.
- Adjust the rotational alignment in relation to anterior tibial tuberosity and then sagittal alignment by setting the rod parallel to the anterior tibial axis. Impact the tabs.
- Insert the 4T Tibial Stylus 2/10 on the Tibial Cutting Block Light (make sure the clip is fully engaged).
- Set the resection height by using the 4T tibial stylus to palpate either the:
  - healthy side (10 mm cut relative to palpated point)
  - worn side (2 mm cut relative to palpated point/exit of saw blade).



#### IMPORTANT

For other resection heights:

- A coarse adjustment can be done by pushing the green wheel.
- A fine adjustment can be done by screwing the green wheel.

#### NOTE

All the wheels can be tightened with the H5 Screwdriver.

- Check the height of the bone cut with the Resection gauge inserted into the slot.
- Insert 2 Threaded Non-Headed Pin Lg 80mm in the 0 mm holes with the Pin Driver AO (or Hall).

#### NOTE

The 4T tibial stylus can be clipped on the lateral side of the 4T tibial resection guide to palpate the medial plateau (or the reverse) by passing the 4T tibial stylus over the 4T tibial bracket.

## 4 Tibial Resection

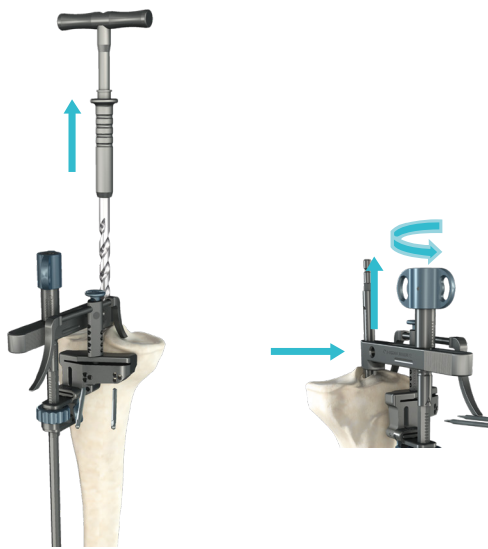

### Removing Tibial Alignment System :

- Remove the 4T tibial stylus.
- Loosen the 4T proximal AP wheel enough to allow movement of the alignment system along the tibial bracket slot.
- Place the T Wrench on Intramedullary rod length 400 mm and remove it.
- Press the wings on the 4T Wheel/Tibial Resection Guide Support and pull to release the tibial alignment system from the Tibial Cutting Block.
- Place the «T» end of the slaphammer into the opening on the 4T tibial bracket and impact upwards to remove the entire EM tibial assembly.

### Completing Tibial Resection :

- Ensure the Tibial Cutting Block is flush with the anterior tibial cortex.
- Check the thickness of the bone cut with the Resection gauge. If required, the Tibial Cutting Block can be moved by +2 or +4 mm to increase the tibial cutting height.
- Use a converging Headed pin length 70 mm or a converging Threaded Non-Headed Pin Lg 80mm to stabilise the Tibial Cutting Block.
- It is possible to check the valgus/varus orientation of the Tibial Resection Guide:
  - Insert the Alignment Device for Tibial Cut into the Tibial Resection Guide
  - Insert an Extramedullary Alignment Rod into one of the 2 holes
  - Check the orientation.
- Make the tibial cut with an oscillating saw (see page 74 for available saw blades)
- Remove the converging Headed pin length 70 mm using the Pin extractor or the converging Threaded Non-Headed Pin Lg 80mm using the Pin driver AO (or Hall).
- Slide the Tibial Cutting Block off the two Threaded Non-Headed Pin Lg 80mm. Leave pins in place in case a recut is required.



### NOTE

A symmetrical tibial cutting block is also available with different options of posterior slope and allows a central approach. The tibial resection guide has +2 and +4 pin hole arrays for recutting additional tibial bone.

## 5 Extension & Flexion Gap Measurement

For a mechanically aligned knee, the aim is to achieve an exactly rectangular gap in extension when the ligaments are under tension. The flexion gap space should be a minimum of 10mm.

This will equate to a total flexion gap of 18mm when the posterior condyle resection has been completed.



### IMPORTANT

The extension gap space should be a minimum of 18mm - the combined thickness of the femoral component (8mm) and smallest tibial component/insert combination (10mm).

### Ligament Balancing in Extension

- Extend the knee
- Assemble the Spacer Base 18mm on the Tibial baseplate handle.
- Insert the spacer with the knee extended.
- Perform checks for varus and valgus tension.
- Check the medial and lateral gaps.
- If the knee is too loose, add a Spacer block 2, 4 or 6mm onto the spacer base.
- If the knee is too tight redo the tibial resection: set the tibial resection guide on the two pins to position +2 or +4, indicating a 2 mm or 4 mm resection.

### Ligament Balancing in Flexion

- Place the knee in flexion.
- Assemble the Spacer Base 10mm on the Tibial baseplate handle (or use the V2 Extra-articular Ligament Balancer if you have it, see Appendix 4).
- Insert the spacer into the flexion space.
- Perform checks for varus/valgus stability.
- Check the medial and lateral gaps. If the knee is too loose add a Spacer block 2, 4 or 6mm onto the spacer base.

## 6 Femoral Sizing

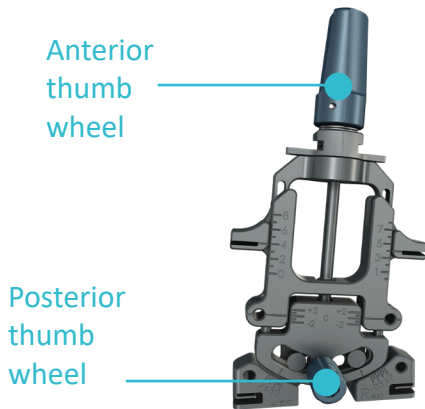

### Femoral Sizer Setup – Standard

- Set the femoral rotation value:
  - Loosen the posterior thumb wheel until the sizer paddles can rotate freely.
  - Align the markings to the desired external rotation value on the corresponding LEFT/RIGHT scale - e.g. 3° LEFT.
  - Re-tighten the posterior thumb wheel, either by hand or with the H5 screwdriver, to lock the femoral sizer in position.
- Check the A/P position is set to the 0mm as default. To adjust the A/P position twist the anterior thumb wheel:
  - Right rotation (+) anterior.
  - Left rotation (-) posterior.
  - One complete rotation = 1 mm.

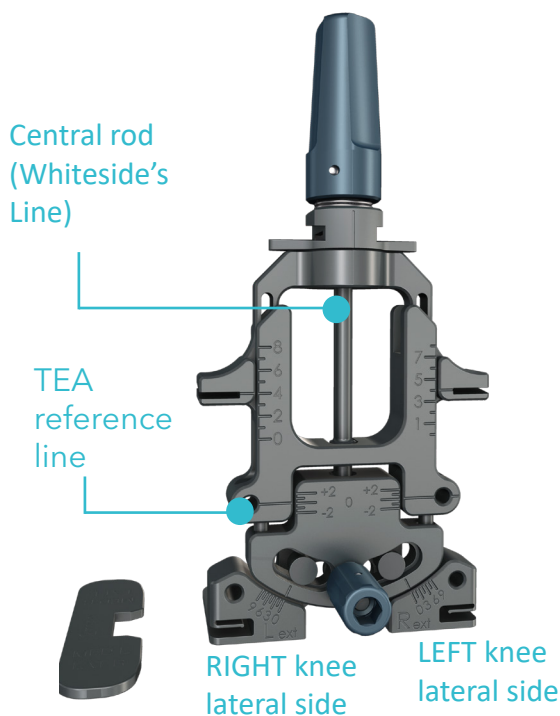

### Femoral Sizer Setup – Lateral Shims

- Unscrew the posterior thumb wheel.
- Set the femoral rotation to 0°.
- Re-tighten the posterior thumb wheel.
- Three thicknesses of shims can be slotted into the lateral side of the femoral sizer to adjust the femoral rotation. The shim thickness 2, 3 or 4 mm gives the value of the rotation based on the lateral condyle respectively approximately 2°, 3° or 4°.
- Shims can be interchanged when the femoral sizer is in situ to achieve the optimal femoral rotation. Use the Trans-Epicondylar Axis (TEA) line on the femoral sizer as a guide.
- The central rod can be used as a secondary reference to align with Whiteside's line.

#### NOTE

1mm thickness of shim = approx. 1° femoral rotation. It will be slightly >1° for smaller femurs and slightly <1° for larger femurs.

## Femoral Stylus Assembly

1. Align the circular cut-out section of the femoral stylus over the top blue thumb wheel.
2. Place the stylus over the thumb wheel until it reaches the shoulder.
3. Locate the tracks on the stylus within the slot on the femoral sizer shoulder to retain it, and slide the stylus to a central position along the track size 3 or 4.

## Attaching Sizer To The Guide

- Position the femoral sizer so that its flat surface is flush against the resected surface of the distal femur and centred mediolaterally. The feet of the sizer must be flush against the posterior condyles.
- Using the tip of the femoral stylus, palpate the deepest point of the femoral anterior sulcus.
- Read the size indicated on the primary size scale on the front of the femoral sizer. Adjust the position of the stylus length according to this size (the tip of the stylus indicates where the exit of the saw blade will be). Confirm the appropriate size.
- Check the anterior resection with the resection gauge inserted in the slots on the femoral sizer.
- The Femoral Sizer and the 4-in-1 Cutting Blocks are based on a Posterior reference. The Femoral Sizer - Support includes an AP adjustment which allows to shift the position of the 4in1 Cutting Block if needed.
- 4-in-1 Cutting Block positioning:
  - 4-in1 Cutting Block: insert 2 Threaded Non-Headed Pins Lg 80mm through the central holes.
  - 4-in1 Cutting Block with Spikes (available on special request only): drill 2 central holes with the 3.2 drill bit length 145 mm.
- Remove the femoral stylus.

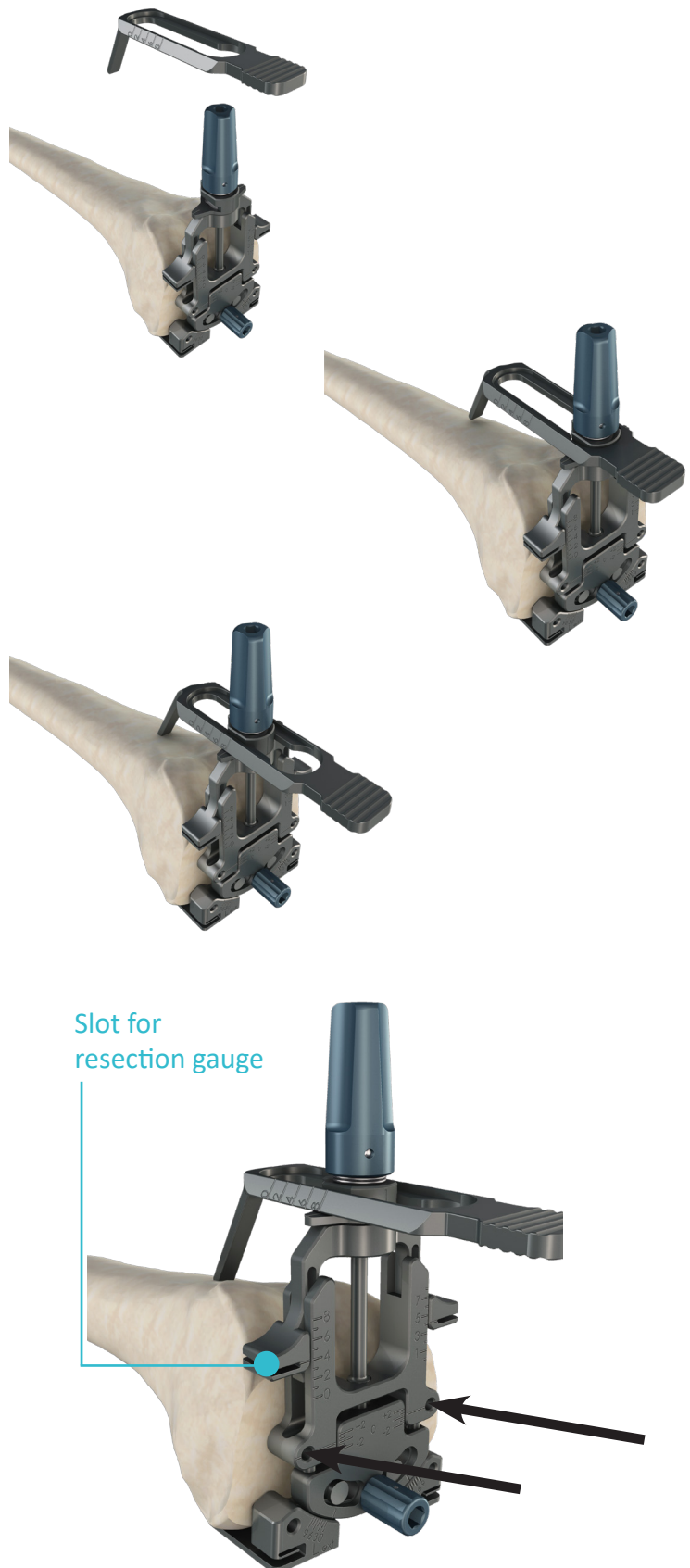

**NOTE**  
 There is also an option to secure the sizer using 2 headed pins inserted in the posterior pin holes.

## 7 4-in-1 Femoral Resection



1. Place the 4-in1 Cutting Block on the two pins, ensuring it rests against the distal resection.
1. If a 4-in1 Cutting Block with Spikes is used, manually place it, aligning the two spikes with the positioning holes previously drilled through femoral sizer. Then Impact the face of the block until the block is flush with the femur.
2. Place the resection gauge through the anterior slot to ensure the desired anterior resection. This check can also be done by inserting the Long Drill bit  $\varnothing 3.2$  length 145 mm in the hole located in the anterior slot (A Hole). The exit of the drill bit will give the exact exit of the sawblade.
3. The 4-in-1 cutting block can be translated anteriorly or posteriorly: If the flexion gap is too loose, use the two posterior central holes (-1 mm B Holes). If the flexion gap is too tight and/or there is an anterior notch, use the two anterior central holes (+1 mm = B' Holes).
4. To remove or reposition the cutting block, remove it by hand. If it's a 4-in1 cutting block with spikes, use the short slaphammer. Place the 'T' end into the front of the block, rotate to lock into place and extract.
5. After final placement of the desired 4-in-1 cutting block, insert two collared threaded pins on the lateral and medial holes to secure the block against the distal resection (C Holes).
6. Check the anterior resection by positioning the Resection Gauge in the anterior slot.
7. Place retractors to protect the medial and lateral collateral ligaments and the popliteal tendon.
8. Use an Amplitude saw blade to complete the anterior, posterior, posterior chamfer and anterior chamfer resections through the cut slots.

## 8 Femoral preparation

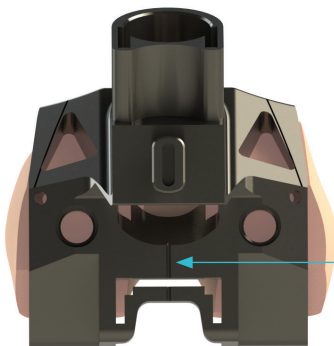
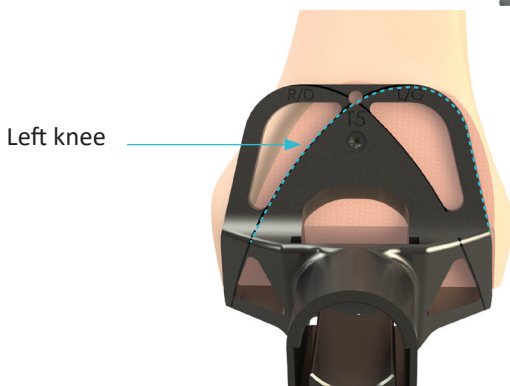

Line indicating the centre of the Femoral preparation guide

### Femoral preparation guide placement :

- Choose the same size of Femoral preparation guide as the 4-in-1 resection guide used previously.
- Place the Universal handle on the oval clip by simultaneously pushing and turning the handle one-quarter turn.
- Place the Femoral preparation guide onto the femur. This guide has the same mediolateral dimensions as the final femoral component. Use the two windows on the anterior face to help position the guide:
  - the outer (lateral) side of the guide corresponds to the outer edge of the final femoral component
  - the inner (medial) side of the window corresponds to the inner edge of the final femoral component (see figure)
- The Femoral preparation guide can be centred in the medio-lateral direction by aligning the line at the centre of the guide over the posterior intercondylar notch.
- Secure the Femoral preparation guide with 3 Headed pins length 30 mm.
- Remove the Universal handle.

### Femoral notch preparation :

- Select the same size of Notch reamer as the Femoral preparation guide.
- Push the Notch reamer into the Femoral preparation guide until it stops.

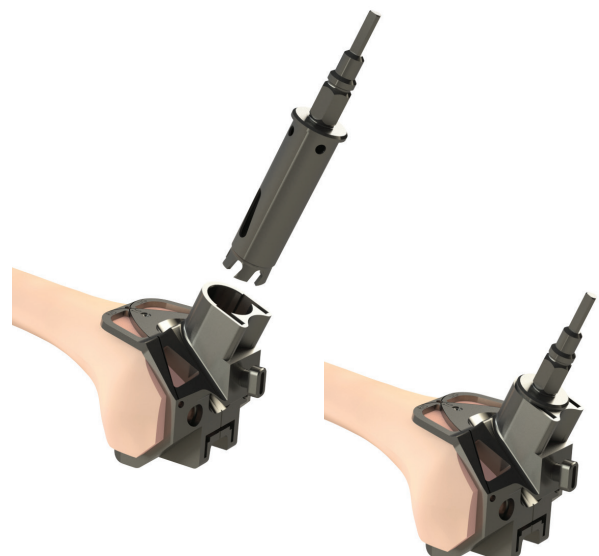

## 8

# Femoral preparation



## Femoral trochlea preparation :

- Select the Trochlea box chisel corresponding to the operated side and assemble it with the Universal handle.
- Prepare the trochlea by inserting the Trochlea box chisel into the Femoral preparation guide.

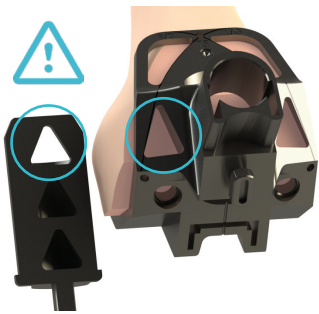

### NOTE

Make sure the Trochlea box chisel is properly oriented from bottom to top.

## Postero-stabilisation cam preparation :

- Assemble the L-shape chisel with the Universal handle.
- Prepare the posterior stabilization cam space by pushing the L-shape chisel into each side of the guide area. Impact the L-shape chisel until it reaches the line corresponding to the size of the Femoral preparation guide being used (guide entrance).
- Prepare the two holes for the pegs with the Drill for peg holes with stop.

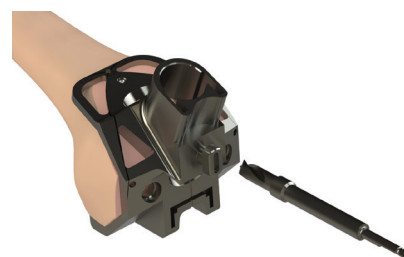
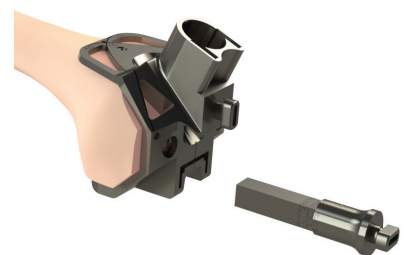



### Final femoral preparation :

- To remove the bone ridge between the distal cut and reamed notch:
  - Select an Osteotome of the same size as the Femoral preparation guide
  - Push the Osteotome into each of the two slots on the outside of the reamer hole until it stops, make sure the « NOTCH SIDE » label faces the notch when pushing in the Osteotome
- Remove the 3 headed pins length 30 mm using the Pin extractor and extract the Femoral preparation guide using the Universal handle.

#### NOTE

If the Osteotome is difficult to pull out, place the T end of the Slap hammer into the hole.

## 9 Positioning of the trial femoral Component

- Select the appropriate side and size of the ANATOMIC Trial femoral component posterior stabilized.
- Set up the 2 Trial pegs for trial femoral component on the trial femoral component, and assemble it on the Femoral component Holder.
- Impact the trial femoral component adjusting the medio-lateral position as needed.
- Finish impacting the trial femoral component using the Femoral component impactor on the Universal handle.
- Any posterior osteophytes can be removed using the Cutting gauge or Unicompartmental osteotome.

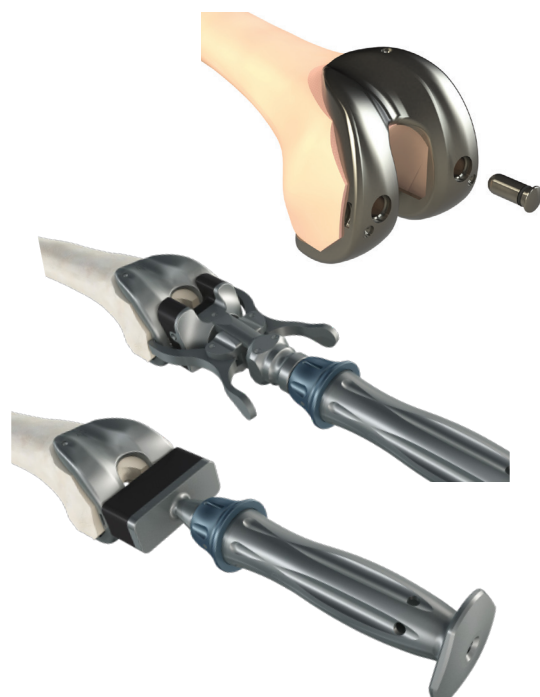

## 10 Tibial preparation



### Placement of trial tibial baseplate :

- Determine the size of the ANATOMIC Trial baseplate posterior stabilized. The tibial baseplate can be the same, or one size larger or smaller than the size of the femoral component.
- Position the trial tibial baseplate onto the tibial cut. The Tibial baseplate handle can be used.
- Once the size has been selected, remove the Tibial baseplate handle, place the same size of ANATOMIC Trial fixed bearing insert, PS (or ANATOMIC Trial fixed bearing insert, PS - Slide) and reattach the Tibial baseplate handle. The lugs on the handle help secure the trial insert to the trial baseplate. In addition, the handle can be used with an Extramedullary alignment rod to verify the rotation, slope and perpendicular alignment of the tibial cut.

### NOTE

Remove the 2 headless pins length 80 mm left in the tibia.

### Trials :

- Put the assembled femoral and tibial trial components through a flexion / extension cycle to assess joint balance and allow the trial baseplate to seat itself in the appropriate rotation (the Tibial baseplate handle can be removed).
- Pick a different trial insert height if needed.
- Use electrocautery to mark the trial baseplate position on the tibia using the two lines on the trial baseplate.
- Remove the assembled tibial trial components and replace the baseplate (without the trial insert) using the marks made on the tibia as a guide.
- Secure the trial baseplate with two Headed pins length 30 mm.



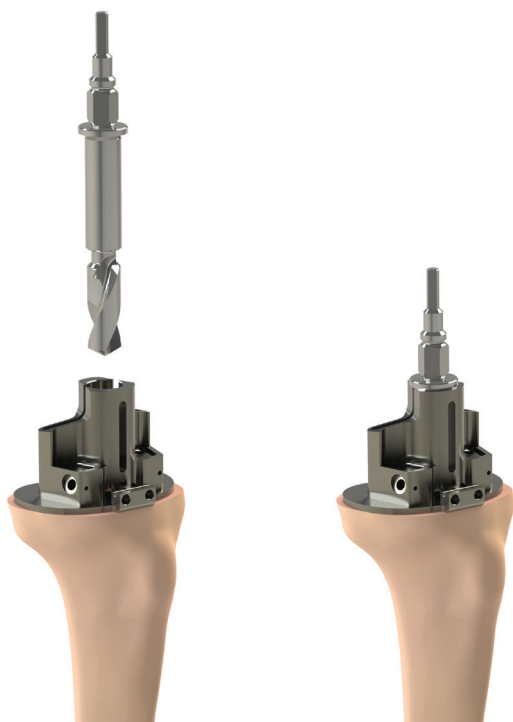

**Keel preparation :**

- Place the Guide for tibial fin punch onto the trial baseplate and verify that the sizes are compatible.
- Removable hand holds can be secured to the sides of the Guide for tibial fin punch to stabilise the entire assembly.
- With the power tool, drive the Reamer for tibial keel into the guide until it stops.

**Fins preparation :**

- Prepare the fins by pushing the appropriate size of the Tibial fin punch (assembled with the Universal handle) until it stops.
- Remove all the instruments using the Tibial baseplate handle and the Pin extractor.

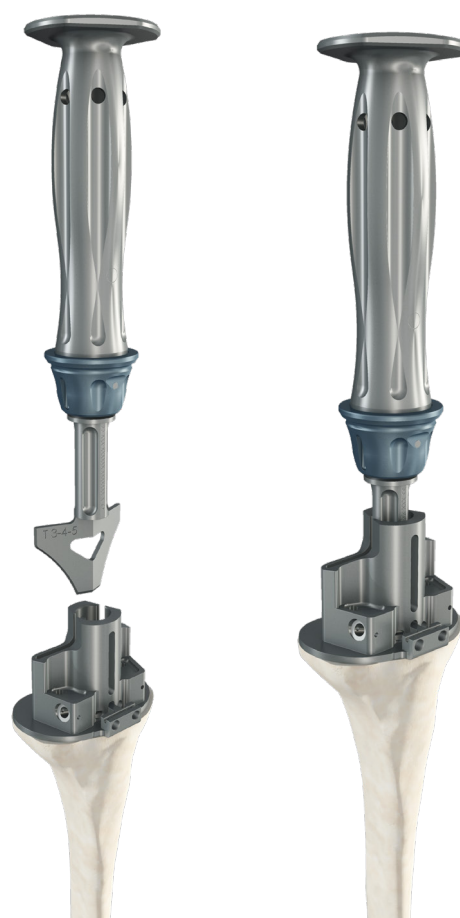

# 11 Patella preparation: resection option



## Patellar preparation:

- Clear osteophytes.

## Position the patellar Resection Clamp:

- Adjust the height of the cut (from 6 to 11mm).
- With the Patellar Resection Guide in the open position, bring the Stylus over the articular surface.

**NOTE:** The handles of the guide are oriented toward the foot.

- Adjust the orientation of the cut plane.
- Tighten and lock the clamp.
- Perform the resection.

## Patellar preparation:

- Use the Patellar Drilling Guide Ø30, Ø33, Ø36 or Ø39 to determine the size of patellar component needed. It is recommended to use the size that allows maximum bone coverage, without presenting a prosthetic overhang.
- Centre and impact the Patellar Drilling Guide.
- Make the 3 holes for the pegs with the Drill Bit for Resurfacing Patella.
- Place the Trial resurfacing patella of the same diameter.
- Test the articulation in the trochlea.

## Patellar implantation:

- Clean and dry the bone surface.
- Apply cement onto the implant.
- Position the implant on the cut.
- Tighten the implant using the Patellar Impaction clamp.
- Remove the excess of cement.
- Keep the clamp until the cement is dry.

## NOTE

The thickness of the patellar implant is 8 mm for all the diameters and it is advisable to leave a remnant of 12 mm of residual bone.

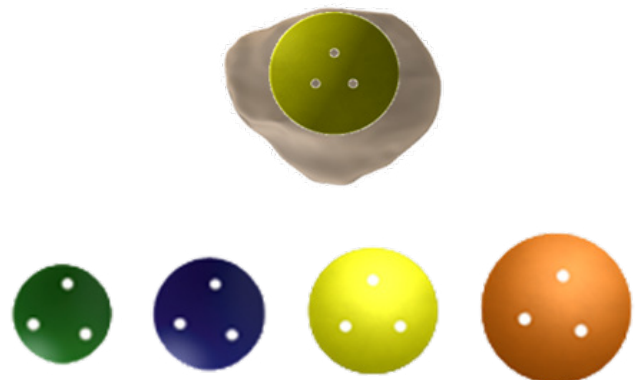

# 11 Patella preparation: resection option



## Patellar preparation :

- Clear osteophytes.

## Position the Patella Reamer Clamp :

- Centre the Trial inset patellar - cemented  $\varnothing$  23 mm – Plastic (or  $\varnothing$  26, or  $\varnothing$  29) on the articular surface of the native patella by centering it on the patellar crest.
- The appropriate size ( $\varnothing$  23, 26 or 29 mm) is determined based on the following criteria:
  - Superior-to-inferior length of the articular surface
  - Width of the patella's medial articular facet
- The size must be as large as possible being slightly smaller (by about 2 mm) than the superior-to-inferior length of the articular surface and must be slightly inside the medial edge of the medial articular facet.
- Assemble the Patella Reamer Surfacing Guide corresponding to the chosen patellar implant size onto the Patella Reamer Clamp and lock it.
- Position the clamp. The inferior jaw on the Patella Reamer Clamp must rest against the anterior side of the patella. The clamp must rest against at least one of the patella's two articular facets.
- Use the thumb knob to tighten the Patella Reamer Clamp.
- Assemble the Reamer for inset cementless patellar of the same size as the chosen clamp onto the power tool.
- Ream the patella until the stop is reached.

## Trials :

- Assemble the Patellar Reamer Impaction Clamp onto the Patella Reamer Clamp and lock it.
- Use it to place the Trial inset patellar - cemented — Plastic of the selected size into the native patella.
- Test the patella tracking.

## Patellar implantation :

- Clean and dry the bone surface.
- Use the Patellar Reamer Impaction Clamp assemble on the Patella Reamer Clamp to insert the chosen patellar component.

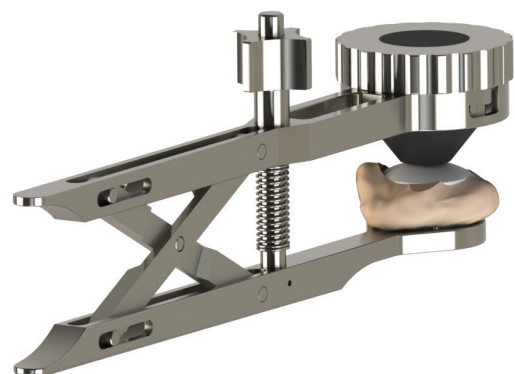

## 12 Definitive implants



### Insertion of chosen tibial baseplate :

- Use the Tibial stem wrench to screw the distal peg into the tibial baseplate (cemented or cementless).
- Wash and dry bone surfaces and the joint space.
- For the cemented version, apply a layer of cement to the bone, the implant surface or to both.
- Position the tibial baseplate and impact it using the Baseplate impactor mounted on the Universal handle.
- For the cemented version, remove any excess cement taking care to limit the movement of the components while the cement is curing.

### Insertion of chosen insert :

- At this point in the procedure, trials can still be performed with a trial insert and the chosen tibial baseplate.
- Hyperflex the knee.
- Slide the insert onto the lateral baseplate rails, and then impact its anterior edge using the Tibial impactor.



#### NOTE

The Tibial impactor has to be slightly anteriorly inclined to ensure a better impaction of the insert.

## 12 Definitive implants



### Insertion of chosen femoral component :

- Assemble the chosen femoral component (cemented or cementless) with the Femoral component holder.
- For the cemented version, apply a layer of cement to the bone, the implant surface or to both.
- Place the femoral component onto the femoral cuts, make sure it is aligned precisely, and then impact it.
- Remove the Femoral component holder.
- Finish impacting the component using the Femoral component impactor and Universal handle.
- For the cemented version, remove any excess cement taking care to limit the movement of the components while the cement is curing.
- Reduce the femoral component onto the insert.

---

# Appendix 1 - Implants extraction

## Tibial extraction :

- To remove the tibial insert, wedge a Lambotte osteotome or bone chisel between the insert and baseplate.
- Assemble the tibial baseplate extractor with the modular handle.
- Screw the extractor into the internal thread on the tibial baseplate.
- Gradually extract the component by tapping under the anvil.



## Femoral extraction :

- Assemble the femoral impactor/extractor on the modular handle.
- Attach to femoral component.
- Gradually extract the component by tapping under the anvil.



# Appendix 2 - Combined Extramedullary tibial system

## Combined extramedullary tibial system:

- For the combined extramedullary tibial system, all assembly steps are identical to the combined intramedullary tibial system, except that the 4T tibial bracket is directly impacted in the tibial spine.
- Adjust the rotational alignment in relation to anterior tibial tuberosity and then sagittal alignment by setting the rod parallel to the anterior tibial axis. Impact the tabs.
- Clip the 4T tibial stylus – 2/10 (or 2/8 or 0/10) on the 4T tibial resection guide (make sure the clip is fully engaged).
- Set the resection height by using the 4T tibial stylus to palpate either the:
  - healthy side (10 mm cut relative to palpated point)
  - worn side (2 mm cut relative to palpated point/exit of saw blade).



### IMPORTANT

#### For other resection heights:

- A coarse adjustment can be done by pushing the green wheel.
- A fine adjustment can be done by screwing the green wheel.

- Check the height of the bone cut with the Resection gauge inserted into the slot.
- Insert 2 Threaded Non-Headed Pins Lg 80mm in the 0 mm holes with the Hall Pin Driver AO (or Hall).

### NOTE

All the wheels can be tightened with the H5 Screwdriver.

---

# Appendix 2 - Combined Extramedullary tibial system

## Removing Tibial Alignment System:

- Remove the 4T tibial stylus.
- Loosen the 4T proximal AP wheel enough to allow movement of the alignment system along the tibial bracket slot.
- Press the wings on the 4T Wheel/Tibial Resection Guide Support and pull to release the tibial alignment system from the Tibial Cutting Block.
- Place the «T» end of the slaphammer into the opening on the 4T tibial bracket and impact upwards to remove the entire EM tibial assembly.

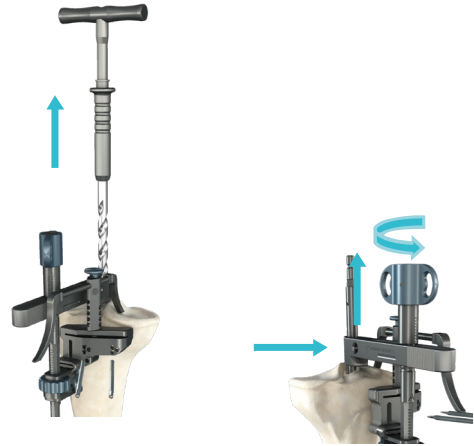

# Appendix 3 - Extramedullary tibial system

## Extramedullary tibial system assembly:

- Screw the 4T Distal AP wheel on the 4T EM Jig ①.
- Insert the 4T Rod for bimalleolar clamp for the Malleolar Clamp into the EM 4T EM Jig ②. Lock it in place with the 4T Distal AP wheel ③.

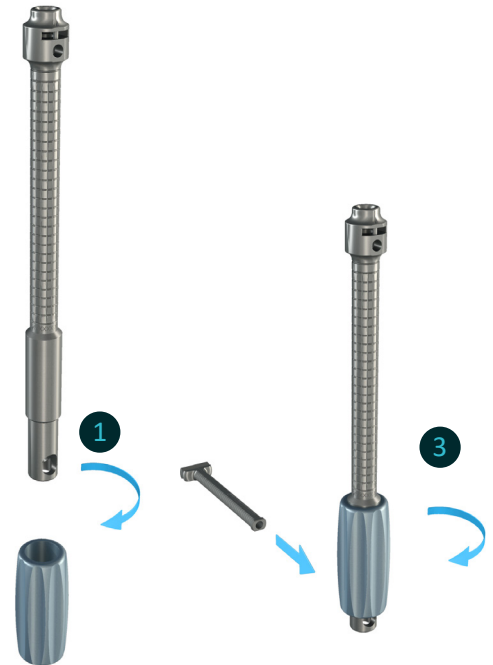
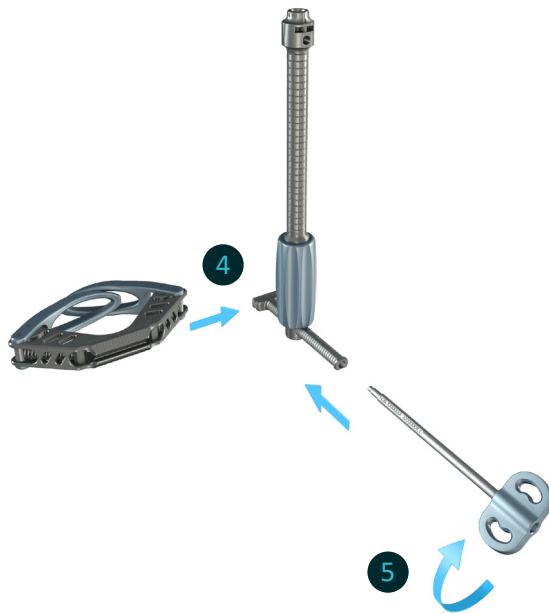

- Assemble the 4T malleolar clamp on the 4T Rod for bimalleolar clamp ④. Lock it in place with the 4T ML wheel for malleolar clamp ⑤.

- Assemble the 4T Tibial resection guide right or left – 0° or 3° with the 4T Wheel/Tibial Resection Guide Support ⑥.
- Assemble the 4T Wheel/Tibial Resection Guide Support with the 4T Aiming without tibial bracket by pressing on the support's green wheel ⑦.



### NOTE

The 'UP' engraving corresponds to the 4T Wheel/Tibial Resection Guide Support's superior side

### NOTE

The 'A' engraving on the 4T Aiming without tibial bracket must be on the anterior side.

- Place the assembly on the 4T EM Jig. Lock them using the 4T Wheel for EM Jig.

### NOTE

The instrumentation set contains two rods. Use the shortest one without the tibial bracket.



---

# Appendix 3 - Extramedullary tibial system

## Extramedullary tibial system:

- Place the 4T malleolar clamp around the ankle (the clamp has a self-opening feature that makes it easier to set up), lock the clamp.
- Adjust the rotational alignment in relation to anterior tibial tuberosity and then sagittal alignment by setting the rod parallel to the anterior tibial axis.
- Clip the 4T tibial stylus – 2/10 (or 2/8 or 0/10) on the 4T tibial resection guide (make sure the clip is fully engaged).
- Set the resection height by using the 4T tibial stylus to palpate either the:
  - healthy side (10 mm cut relative to palpated point)
  - worn side (2 mm cut relative to palpated point/exit of saw blade).



### IMPORTANT

#### For other resection heights:

- A coarse adjustment can be done by pushing the green wheel.
- A fine adjustment can be done by screwing the green wheel.

- Check the height of the bone cut with the Resection gauge inserted into the slot.
- Insert 2 Threaded Non-Headed Pins Lg 80mm in the 0 mm holes with the Hall Pin Driver AO (or Hall).
- Remove the 4T tibial stylus.
- Press the wings on the 4T Wheel/ Tibial Resection Guide Support and pull to release the tibial alignment system from the Tibial Cutting Block.

# Appendix 4 - Ligament balancer

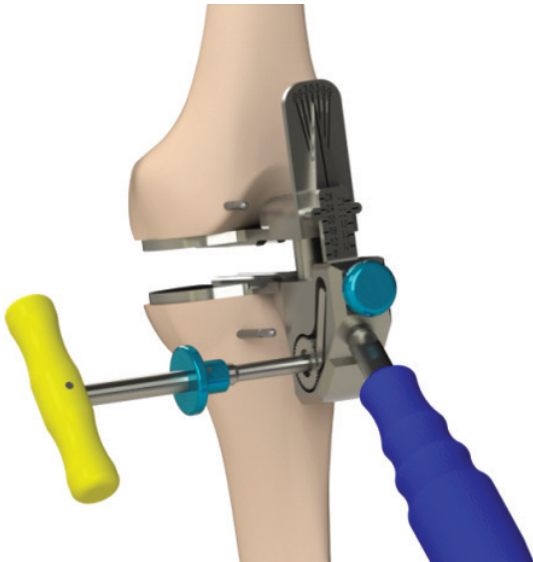

## Extension gap measurement :

This step is carried out after performing the distal femoral and tibial cuts. The goal is to achieve a rectangular gap in extension when the ligaments are under tension. The resulting gap will be measured and should be the same when the knee is flexed.

- Insert the Extra-articular ligament balancer V2 into the knee joint with the knee extended.
- Insert the Snap Screwdriver H5 into the balancer's cog wheel.
- Turn the Snap screwdriver H5 to operate the distraction mechanism and apply the desired amount of tension. Do not apply excessive distraction, otherwise the knee will flex. The knee must stay extended during the measurements.
- Make sure the tibial and distal femoral cuts are parallel, and check the height of the tibiofemoral gap.
- If the tibiofemoral gap is less than the 18 mm minimum gap needed (10 mm for the tibial component plus 8 mm for the femoral component), redo the tibial or distal femoral cut.

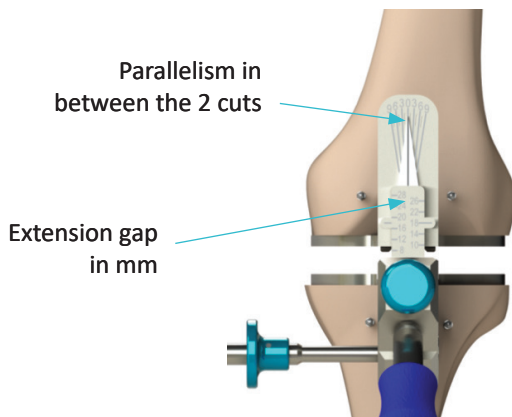

Minimum gap in extension :  
 $18 \text{ mm} = 10 \text{ mm (tibial component)} + 8 \text{ mm (femoral component)}$

### NOTE

Ligament can be released to achieve desired ligament balance (value of 0 on Balancer).

# Appendix 4 - Ligament balancer

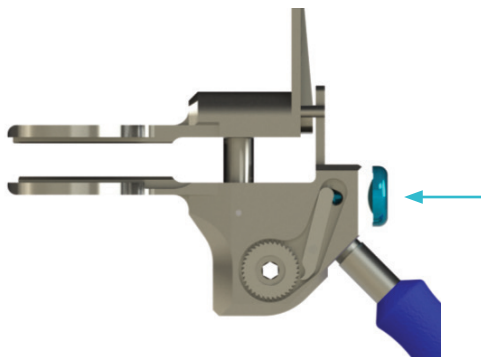

- Press the blue unlock button to remove the Extra-articular ligament balancer V2 from the joint.

## NOTE

Remove the 2 Headless pins length 80 mm left in anterior part.

## Flexion gap measurement :

- Flex the knee.
- Insert the Extra-articular ligament balancer V2 and apply the desired tension (same procedure as with knee extended).
- Read the flexion gap value and femur rotation value (induced by ligament laxity) relative to the tibia.
- Make sure the flexion gap is equal to the extension gap (8 mm must be subtracted from the extension gap value).

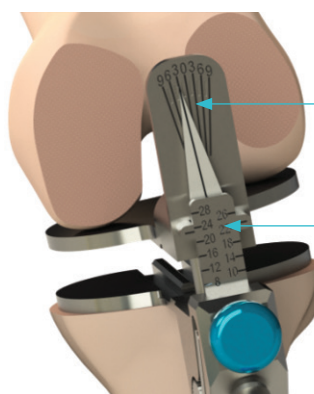

Femoral rotation in degree

Read flexion gap here (subtract 8 mm from extension gap)

# Appendix 4 - Ligament balancer

## Assembly and disassembly of the ligament balancer

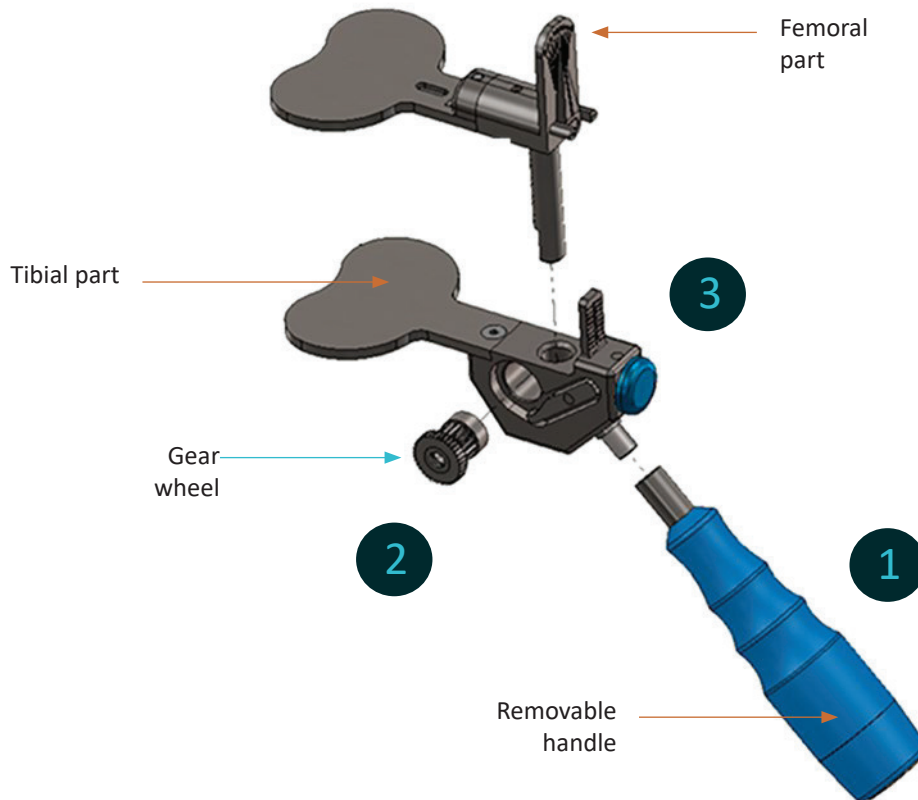

### Assembly of Balancer :

- 1 Screw the removable handle onto the tibial housing.
- 2 Place the gear wheel into the lateral opening on the tibial housing.
- 3 Press the blue button and insert the femoral housing on top of the tibial housing

### Dissassembly of the Balancer :

Repeat the above steps in the reverse order.



---

# Instrumentation

The ANATOMIC conventional instrumentation\* consists of 5 trays:

- Instrumentation set for **Common + Tibial cut**
- Instrumentation set for **Common + Femoral cuts**
- Instrumentation set for **ANATOMIC – Femoral trials**
- Instrumentation set for **ANATOMIC – Femoral preparation**
- Instrumentation set for **ANATOMIC – Tibial trials**

And either of:

- Instrumentation set for **SCORE Primary - Patellar resection set (Conventional)**
- Instrumentation set for **SCORE - Patella set - Patella reaming**

In addition:

- Instrumentation set for **TKA LOAN OPTION Conv - iIMAGE - CAS**
- Instrumentation set for **Knee Ligament Balancer**
- Instrumentation set for **ANATOMIC – Tibial trials th. 18/20**
- Instrumentation set for **ANATOMIC - Size 0 Fem + Tib**
- Instrumentation set for **ANATOMIC - Size 8 Fem + Tib**
- Sterile large saw blades
- Sterile medium saw blades

\* Not all devices presented in this Surgical Technique may be registered in your country. Please contact your Amplitude Sales Representative for availability.

# Instrumentation

Common set + Tibial cut

2-02999102

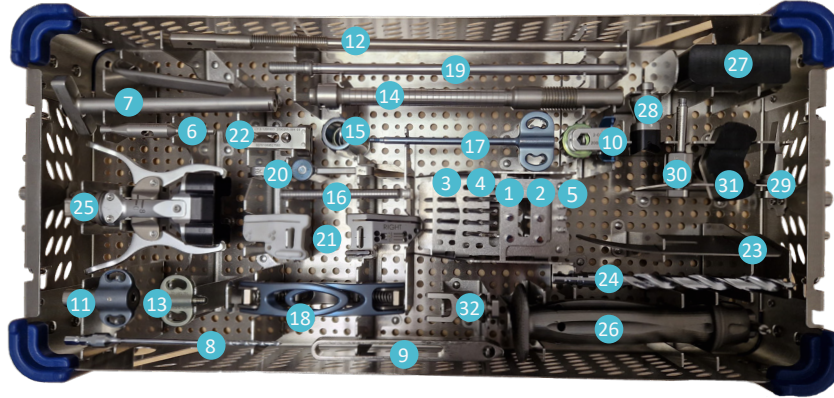

Item	Name	Product N°	Qty
1	Headed pin length 30 mm	2-0201301	3
2	Headed pin length 70 mm	2-0201302	3
3	Headless pin length 80 mm	2-0201400	6
4	Threaded Non-Headed Pin Lg 80mm	2-0255402	6
5	Collared threaded pin Ø3,2-L57	2-0238857	3
6	Pin Driver AO	2-0201200	1
<b>SUBSTITUTE</b>	HALL Pin driver	2-1201200	1
7	Specific pin extractor	8-0202700	1
8	Long Drill bit Ø3.2 length 145 mm	2-0102400	1
<b>SUBSTITUTE</b>	HALL Ø3,2 drill bit length 145 mm	2-0248700	1
9	4T tibial bracket	2-0236600	1
10	4T Wheel/Tibial Resection Guide Support	2-0236700	1
11	4T Proximal AP Wheel	2-0236800	1
12	4T Aiming with tibial bracket	2-0236900	1
13	4T Wheel for EM Jig	2-0237000	1
14	4T EM Jig	2-0237100	1
15	4T Distal AP wheel	2-0237200	1
16	4T Rod for bimalleolar clamp	2-0237300	1
17	4T ML wheel for malleolar clamp	2-0237400	1
18	4T malleolar clamp	2-0237500	1
19	4T Aiming without tibial bracket	2-0239000	1
20	4T tibial stylus – 2/10	2-0236502	1
<b>SUBSTITUTE</b>	4T tibial stylus – 0/10	2-0236500	1
<b>SUBSTITUTE</b>	4T tibial stylus – 2/8	2-0236501	1
21	Tibial Cutting Block Light 3° - Right	2-1200103	1
21	Tibial Cutting Block Light 3° - Left	2-1200104	1
<b>SUBSTITUTE</b>	Tibial Cutting Block Light 0° - Right	2-1200100	1
<b>SUBSTITUTE</b>	Tibial Cutting Block Light 0° - Left	2-1200101	1
<b>SUBSTITUTE</b>	4T tibial resection guide left - 0°	2-0236400	1
<b>SUBSTITUTE</b>	4T Tibial resection guide right – 0°	2-0236401	1
<b>SUBSTITUTE</b>	4T Tibial resection guide left – 3°	2-0237600	1
<b>SUBSTITUTE</b>	4T tibial resection guide right – 3°	2-0237700	1



# Instrumentation

Common set + Tibial cut

2-02999102

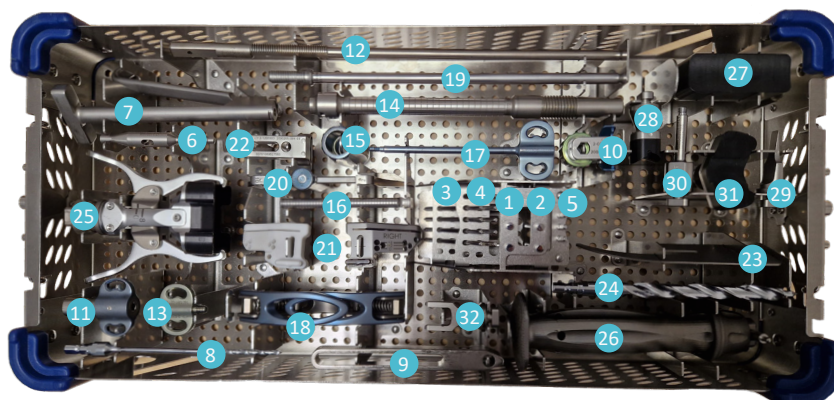

Item	Name	Product N°	Qty
22	Alignement Device for Tibial Cut	2-1200300	1
23	Resection gauge	2-0204500	1
24	Intramedullary drill bit	2-0200100	1
<b>SUBSTITUTE</b>	Intramedullary hall drill BIT Ø10 mm	2-0245400	1
25	Femoral Impactor / Extractor	2-1201300	1
26	Modular Handle	2-0255300	1
27	Femoral Impactor - Universal	2-0241200	1
28	Insert Impactor - Universal	2-0241300	1
29	Insert Extractor	2-0241500	1
30	Tibial Baseplate Extractor	2-0241600	1
31	Tibial impactor - Universal	2-0241900	1
32	Modular Tibial Stem Wrench	2-1201000	1

# Instrumentation

Common set + Femoral cuts

2-02999103

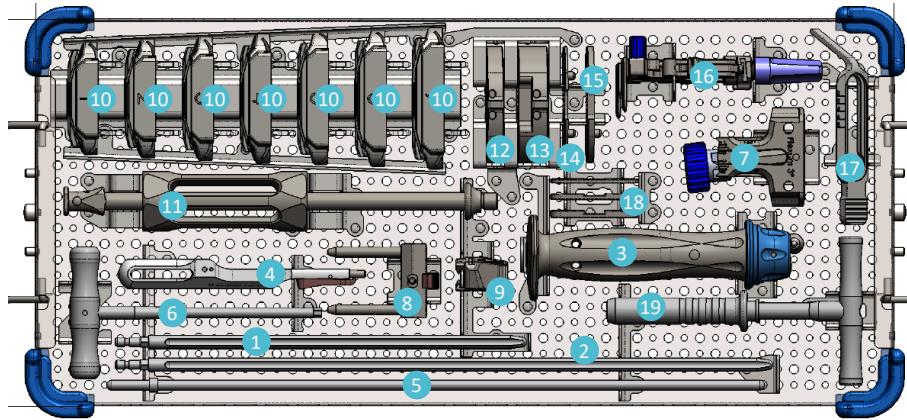

Item	Name	Product N°	Qty
1	Intramedullary rod length 250 mm	2-0200200	1
2	Intramedullary rod length 400 mm	2-0200300	1
3	Modular Handle	2-0255300	1
4	Tibial baseplate handle	2-0223500	1
5	Extramedullary alignment rod	2-0200600	1
6	H5 Screwdriver	2-0200800	1
7	Femoral Valgus Alignment Guide 3°	2-0226603	1
<b>SUBSTITUTE</b>	Femoral Valgus Alignment Guide 0°	2-0226600	1
<b>SUBSTITUTE</b>	Femoral Valgus Alignment Guide 6°	2-0226606	1
8	Distal Slider - Clip System	2-1200700	1
9	Distal Cutting Block 10 mm - Clip System	2-1200600	1
<b>SUBSTITUTE</b>	Distal Cutting Block 8 mm - Clip System	2-1200500	1
10	4-in-1 Cutting Block Size 1	2-0255101	1
10	4-in-1 Cutting Block Size 2	2-0255102	1
10	4-in-1 Cutting Block Size 3	2-0255103	1
10	4-in-1 Cutting Block Size 4	2-0255104	1
10	4-in-1 Cutting Block Size 5	2-0255105	1
10	4-in-1 Cutting Block Size 6	2-0255106	1
10	4-in-1 Cutting Block Size 7	2-0255107	1
11	Short Slap hammer	2-0255700	1
12	Spacer Base 10mm	2-0255510	1
13	Spacer Base 18mm	2-0255518	1
14	Spacer Block 2mm	2-0255602	1
15	Spacer Block 4mm	2-0255604	1
16	Femoral Sizer	2-1201700	1
17	Femoral Sizer - Stylus	2-0257100	1
18	Shim 2 mm - Femoral Sizer	2-0257300	1
18	Shim 3 mm - Femoral Sizer	2-0257400	1
18	Shim 4 mm - Femoral Sizer	2-0257500	1
19	T wrench	2-0200400	1

# Instrumentation

Common set + Femoral cuts

2-02999103

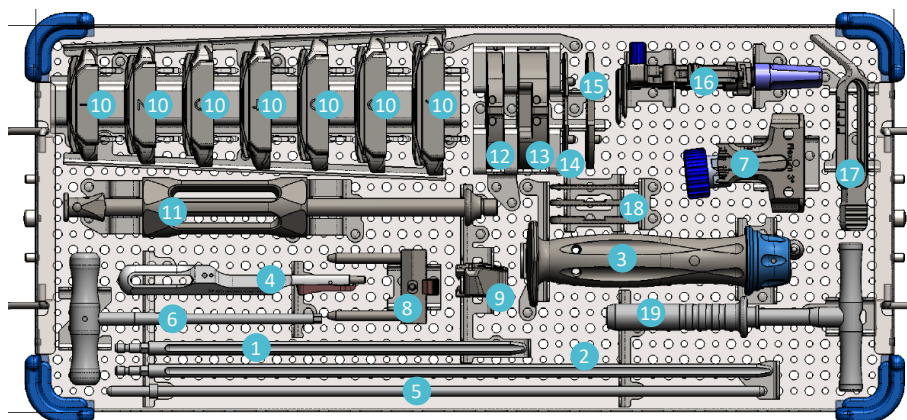

Item	Name	Product N°	Qty
SUBSTITUTE	4-in1 Cutting Block with Spikes Size 1	2-0255201	1
SUBSTITUTE	4-in1 Cutting Block with Spikes Size 2	2-0255202	1
SUBSTITUTE	4-in1 Cutting Block with Spikes Size 3	2-0255203	1
SUBSTITUTE	4-in1 Cutting Block with Spikes Size 4	2-0255204	1
SUBSTITUTE	4-in1 Cutting Block with Spikes Size 5	2-0255205	1
SUBSTITUTE	4-in1 Cutting Block with Spikes Size 6	2-0255206	1
SUBSTITUTE	4-in1 Cutting Block with Spikes Size 7	2-0255207	1

# Instrumentation

## ANATOMIC – Femoral preparation

2-02999153



Item	Name	Product N°	Qty
1	Notch reamer Size 1	2-0231301	1
1	Notch reamer Size 2	2-0231302	1
1	Notch reamer Size 3	2-0231303	1
1	Notch reamer Size 4	2-0231304	1
1	Notch reamer Size 5	2-0231305	1
1	Notch reamer Size 6	2-0231306	1
1	Notch reamer Size 7	2-0231307	1
<b>SUBSTITUTE</b>	HALL notch reamer Size 1	2-0245901	1
<b>SUBSTITUTE</b>	HALL notch reamer Size 2	2-0245902	1
<b>SUBSTITUTE</b>	HALL notch reamer Size 3	2-0245903	1
<b>SUBSTITUTE</b>	HALL notch reamer Size 4	2-0245904	1
<b>SUBSTITUTE</b>	HALL notch reamer Size 5	2-0245905	1
<b>SUBSTITUTE</b>	HALL notch reamer Size 6	2-0245906	1
<b>SUBSTITUTE</b>	HALL notch reamer Size 7	2-0245907	1
2	Femoral preparation guide Size 1	2-0230701	1
2	Femoral preparation guide Size 2	2-0230702	1
2	Femoral preparation guide Size 3	2-0230703	1
2	Femoral preparation guide Size 4	2-0230704	1
2	Femoral preparation guide Size 5	2-0230705	1
2	Femoral preparation guide Size 6	2-0230706	1
2	Femoral preparation guide Size 7	2-0230707	1
3	Drill for peg holes	2-0204000	1
<b>SUBSTITUTE</b>	HALL drill bit for femoral peg	2-0245500	1
4	L-shape chisel	2-0231700	1
5	Right Trochlea box chisel	2-0231400	1
6	Left Trochlea box chisel	2-0231500	1
7	Osteotome Size 0-1-2	2-0233700	1
8	Osteotome Size 3-4-5	2-0233701	1
9	Osteotome Size 6-7-8	2-0233702	1

# Instrumentation

## ANATOMIC – Femoral trials

2-02999154

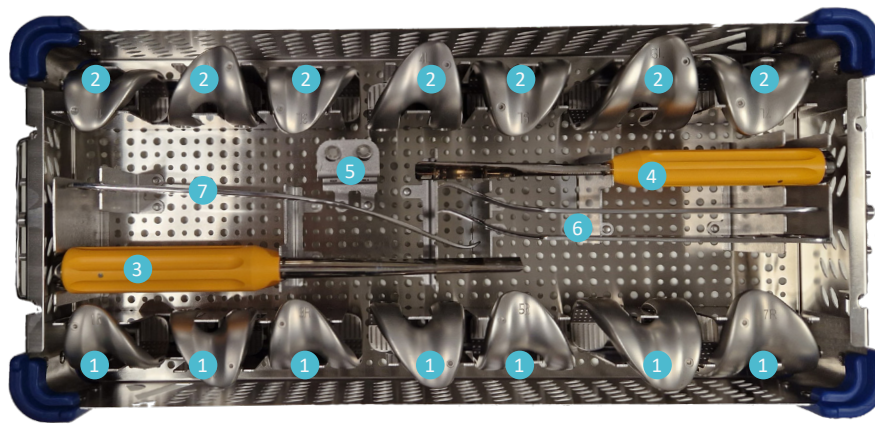

Item	Name	Product N°	Qty
1	ANATOMIC Trial femoral component posterior stabilized right Size 1	2-0231101	1
1	ANATOMIC Trial femoral component posterior stabilized right Size 2	2-0231102	1
1	ANATOMIC Trial femoral component posterior stabilized right Size 3	2-0231103	1
1	ANATOMIC Trial femoral component posterior stabilized right Size 4	2-0231104	1
1	ANATOMIC Trial femoral component posterior stabilized right Size 5	2-0231105	1
1	ANATOMIC Trial femoral component posterior stabilized right Size 6	2-0231106	1
1	ANATOMIC Trial femoral component posterior stabilized right Size 7	2-0231107	1
2	ANATOMIC Trial femoral component posterior stabilized left Size 1	2-0231201	1
2	ANATOMIC Trial femoral component posterior stabilized left Size 2	2-0231202	1
2	ANATOMIC Trial femoral component posterior stabilized left Size 3	2-0231203	1
2	ANATOMIC Trial femoral component posterior stabilized left Size 4	2-0231204	1
2	ANATOMIC Trial femoral component posterior stabilized left Size 5	2-0231205	1
2	ANATOMIC Trial femoral component posterior stabilized left Size 6	2-0231206	1
2	ANATOMIC Trial femoral component posterior stabilized left Size 7	2-0231207	1
3	Cutting gauge	2-0206500	1
4	Unicompartmental osteotome	2-0221500	1
5	Trial peg for trial femoral component	2-0233300	2
6	Retr./Handle Hohmann 24 cm 18.0 mm*	18602	2
7	Retr./Handle Hohmann 26.5 cm 24.0 mm*	18703	1

\*Not all devices presented in this Surgical Technique may be registered in your country. Please contact your Amplitude Sales Representative for availability.



# Instrumentation

ANATOMIC – Tibial trials

2-02999155

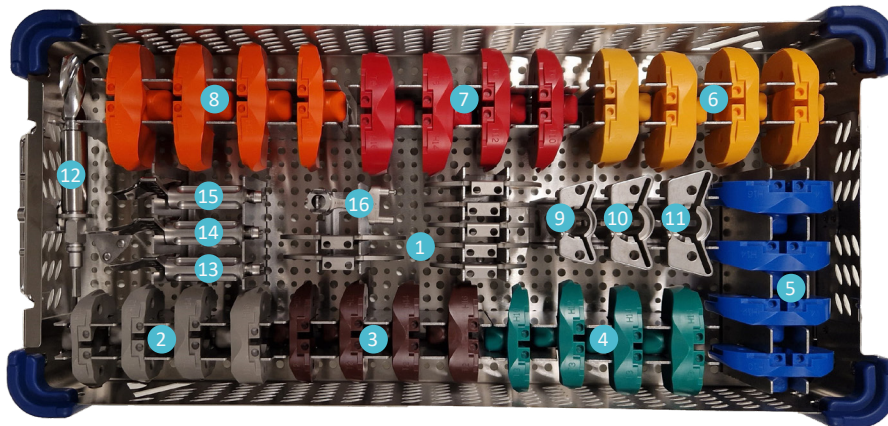

Item	Name	Product N°	Qty
1	ANATOMIC Trial baseplate posterior stabilized Size 1	2-0231001	1
1	ANATOMIC Trial baseplate posterior stabilized Size 2	2-0231002	1
1	ANATOMIC Trial baseplate posterior stabilized Size 3	2-0231003	1
1	ANATOMIC Trial baseplate posterior stabilized Size 4	2-0231004	1
1	ANATOMIC Trial baseplate posterior stabilized Size 5	2-0231005	1
1	ANATOMIC Trial baseplate posterior stabilized Size 6	2-0231006	1
1	ANATOMIC Trial baseplate posterior stabilized Size 7	2-0231007	1
2	ANATOMIC Trial fixed bearing insert, PS - Size 1, Height 10 mm	2-0230610	1
2	ANATOMIC Trial fixed bearing insert, PS - Size 1, Height 12 mm	2-0230611	1
2	ANATOMIC Trial fixed bearing insert, PS - Size 1, Height 14 mm	2-0230612	1
2	ANATOMIC Trial fixed bearing insert, PS - Size 1, Height 16 mm	2-0230613	1
3	ANATOMIC Trial fixed bearing insert, PS - Size 2, Height 10 mm	2-0230620	1
3	ANATOMIC Trial fixed bearing insert, PS - Size 2, Height 12 mm	2-0230621	1
3	ANATOMIC Trial fixed bearing insert, PS - Size 2, Height 14 mm	2-0230622	1
3	ANATOMIC Trial fixed bearing insert, PS - Size 2, Height 16 mm	2-0230623	1
4	ANATOMIC Trial fixed bearing insert, PS - Size 3, Height 10 mm	2-0230630	1
4	ANATOMIC Trial fixed bearing insert, PS - Size 3, Height 12 mm	2-0230631	1
4	ANATOMIC Trial fixed bearing insert, PS - Size 3, Height 14 mm	2-0230632	1
4	ANATOMIC Trial fixed bearing insert, PS - Size 3, Height 16 mm	2-0230633	1
5	ANATOMIC Trial fixed bearing insert, PS - Size 4, Height 10 mm	2-0230640	1
5	ANATOMIC Trial fixed bearing insert, PS - Size 4, Height 12 mm	2-0230641	1
5	ANATOMIC Trial fixed bearing insert, PS - Size 4, Height 14 mm	2-0230642	1
5	ANATOMIC Trial fixed bearing insert, PS - Size 4, Height 16 mm	2-0230643	1
6	ANATOMIC Trial fixed bearing insert, PS - Size 5, Height 10 mm	2-0230650	1
6	ANATOMIC Trial fixed bearing insert, PS - Size 5, Height 12 mm	2-0230651	1
6	ANATOMIC Trial fixed bearing insert, PS - Size 5, Height 14 mm	2-0230652	1
6	ANATOMIC Trial fixed bearing insert, PS - Size 5, Height 16 mm	2-0230653	1
7	ANATOMIC Trial fixed bearing insert, PS - Size 6, Height 10 mm	2-0230660	1
7	ANATOMIC Trial fixed bearing insert, PS - Size 6, Height 12 mm	2-0230661	1
7	ANATOMIC Trial fixed bearing insert, PS - Size 6, Height 14 mm	2-0230662	1
7	ANATOMIC Trial fixed bearing insert, PS - Size 6, Height 16 mm	2-0230663	1
8	ANATOMIC Trial fixed bearing insert, PS - Size 7, Height 10 mm	2-0230670	1



# Instrumentation

ANATOMIC – Tibial trials

2-02999155

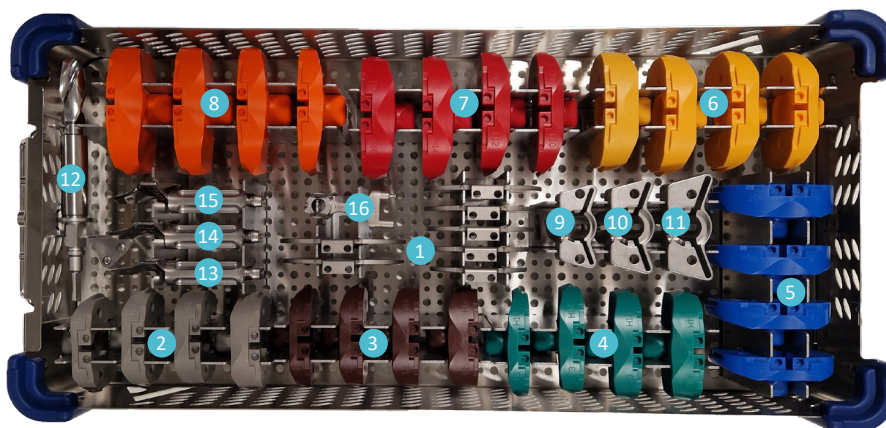

Item	Name	Product N°	Qty
8	ANATOMIC Trial fixed bearing insert, PS - Size 7, Height 12 mm	2-0230671	1
8	ANATOMIC Trial fixed bearing insert, PS - Size 7, Height 14 mm	2-0230672	1
8	ANATOMIC Trial fixed bearing insert, PS - Size 7, Height 16 mm	2-0230673	1
<b>SUBSTITUTE</b>	ANATOMIC Trial fixed bearing insert, PS - Slide - Size 1, Height 10 mm	2-0253210	1
<b>SUBSTITUTE</b>	ANATOMIC Trial fixed bearing insert, PS - Slide - Size 1, Height 12 mm	2-0253211	1
<b>SUBSTITUTE</b>	ANATOMIC Trial fixed bearing insert, PS - Slide - Size 1, Height 14 mm	2-0253212	1
<b>SUBSTITUTE</b>	ANATOMIC Trial fixed bearing insert, PS - Slide - Size 1, Height 16 mm	2-0253213	1
<b>SUBSTITUTE</b>	ANATOMIC Trial fixed bearing insert, PS - Slide - Size 2, Height 10 mm	2-0253220	1
<b>SUBSTITUTE</b>	ANATOMIC Trial fixed bearing insert, PS - Slide - Size 2, Height 12 mm	2-0253221	1
<b>SUBSTITUTE</b>	ANATOMIC Trial fixed bearing insert, PS - Slide - Size 2, Height 14 mm	2-0253222	1
<b>SUBSTITUTE</b>	ANATOMIC Trial fixed bearing insert, PS - Slide - Size 2, Height 16 mm	2-0253223	1
<b>SUBSTITUTE</b>	ANATOMIC Trial fixed bearing insert, PS - Slide - Size 3, Height 10 mm	2-0253230	1
<b>SUBSTITUTE</b>	ANATOMIC Trial fixed bearing insert, PS - Slide - Size 3, Height 12 mm	2-0253231	1
<b>SUBSTITUTE</b>	ANATOMIC Trial fixed bearing insert, PS - Slide - Size 3, Height 14 mm	2-0253232	1
<b>SUBSTITUTE</b>	ANATOMIC Trial fixed bearing insert, PS - Slide - Size 3, Height 16 mm	2-0253233	1
<b>SUBSTITUTE</b>	ANATOMIC Trial fixed bearing insert, PS - Slide - Size 4, Height 10 mm	2-0253240	1
<b>SUBSTITUTE</b>	ANATOMIC Trial fixed bearing insert, PS - Slide - Size 4, Height 12 mm	2-0253241	1
<b>SUBSTITUTE</b>	ANATOMIC Trial fixed bearing insert, PS - Slide - Size 4, Height 14 mm	2-0253242	1
<b>SUBSTITUTE</b>	ANATOMIC Trial fixed bearing insert, PS - Slide - Size 4, Height 16 mm	2-0253243	1
<b>SUBSTITUTE</b>	ANATOMIC Trial fixed bearing insert, PS - Slide - Size 5, Height 10 mm	2-0253250	1
<b>SUBSTITUTE</b>	ANATOMIC Trial fixed bearing insert, PS - Slide - Size 5, Height 12 mm	2-0253251	1
<b>SUBSTITUTE</b>	ANATOMIC Trial fixed bearing insert, PS - Slide - Size 5, Height 14 mm	2-0253252	1
<b>SUBSTITUTE</b>	ANATOMIC Trial fixed bearing insert, PS - Slide - Size 5, Height 16 mm	2-0253253	1
<b>SUBSTITUTE</b>	ANATOMIC Trial fixed bearing insert, PS - Slide - Size 6, Height 10 mm	2-0253260	1
<b>SUBSTITUTE</b>	ANATOMIC Trial fixed bearing insert, PS - Slide - Size 6, Height 12 mm	2-0253261	1
<b>SUBSTITUTE</b>	ANATOMIC Trial fixed bearing insert, PS - Slide - Size 6, Height 14 mm	2-0253262	1
<b>SUBSTITUTE</b>	ANATOMIC Trial fixed bearing insert, PS - Slide - Size 6, Height 16 mm	2-0253263	1
<b>SUBSTITUTE</b>	ANATOMIC Trial fixed bearing insert, PS - Slide - Size 7, Height 10 mm	2-0253270	1
<b>SUBSTITUTE</b>	ANATOMIC Trial fixed bearing insert, PS - Slide - Size 7, Height 12 mm	2-0253271	1
<b>SUBSTITUTE</b>	ANATOMIC Trial fixed bearing insert, PS - Slide - Size 7, Height 14 mm	2-0253272	1
<b>SUBSTITUTE</b>	ANATOMIC Trial fixed bearing insert, PS - Slide - Size 7, Height 16 mm	2-0253273	1
9	Guide for tibial fin punch Size 0-1-2	2-0230801	1



# Instrumentation

ANATOMIC – Tibial trials

2-02999155

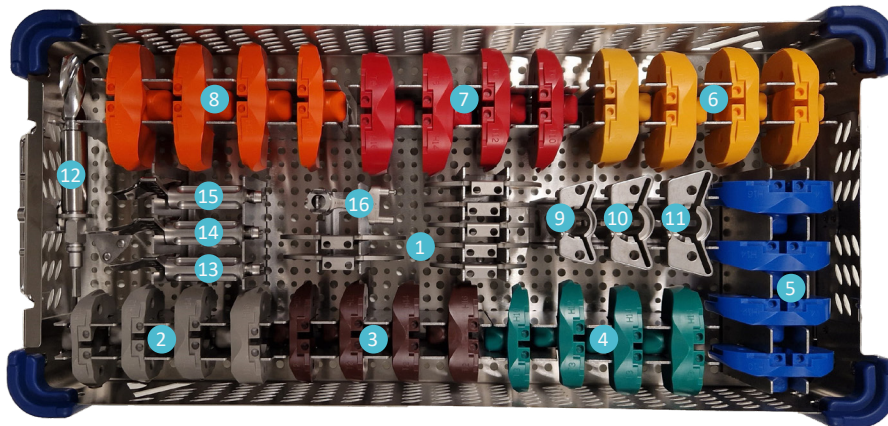

Item	Name	Product N°	Qty
10	Guide for tibial fin punch Size 3-4-5	2-0230802	1
11	Guide for tibial fin punch Size 6-7-8	2-0230803	1
12	Reamer for tibial keel	2-0231600	1
<b>SUBSTITUTE</b>	HALL drill bit for tibial keel preparation	2-0245800	1
13	Tibial fin punch size 0-1-2	2-0230901	1
14	Tibial fin punch size 3-4-5	2-0230902	1
15	Tibial fin punch size 6-7-8	2-0230903	1
16	Reference body support for tibial baseplate handle	2-0223600	1

# Instrumentation

## Patella resection set (incl. Ø39)

2-02999163

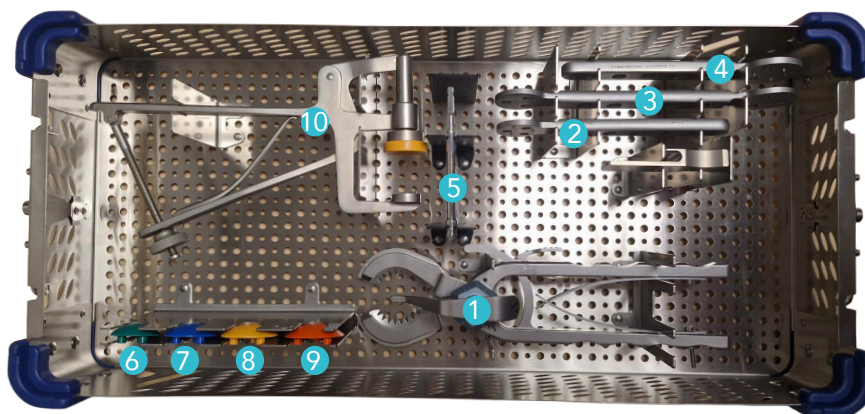

Item	Name	Product No.	Qty
1	Patellar Resection Clamp	2-0258100	1
<b>ALTERNATIVE</b>	Patellar Resection Forceps	2-0206700	
<b>ALTERNATIVE</b>	Patellar resection gauge	2-0208400	
2	Patellar Drilling Guide Ø30	2-0204900	1
3	Patellar Drilling Guide Ø33 and Ø36	2-0205000	1
4	Patellar Drilling Guide Ø39	2-0226000	1
5	Drill Bit for Resurfacing Patella	2-0205100	1
<b>ALTERNATIVE</b>	HALL drill bit for resurfacing patella	2-0245600	
6	Trial resurfacing patella Ø 30	2-0205330	1
7	Trial resurfacing patella Ø 33	2-0205333	1
8	Trial resurfacing patella Ø 36	2-0205336	1
9	Trial resurfacing patella Ø 39	2-0205339	1
10	Patellar Impaction Clamp	2-0206100	1

# Instrumentation

Score - Patella set - Patella reaming

2-0299917

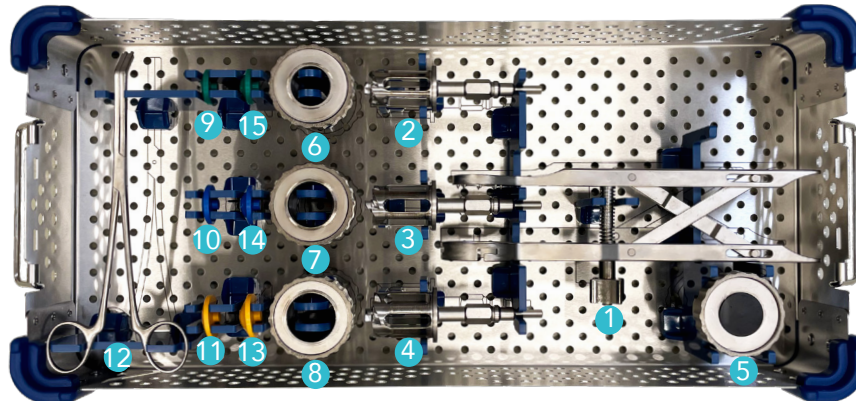

Item	Name	Product No.	Qty
1	Patella Reamer Clamp	2-0216600	1
2	Reamer for inset cementless patellar Ø 23	2-0216523	1
3	Reamer for inset cementless patellar Ø 26	2-0216526	1
4	Reamer for inset cementless patellar Ø 29	2-0216529	1
5	Patellar Reamer Impaction Clamp	2-0216800	1
6	Patella Reamer Surfacing Guides Ø 23	2-0216723	1
7	Patella Reamer Surfacing Guides Ø 26	2-0216726	1
8	Patella Reamer Surfacing Guides Ø 29	2-0216729	1
9	Trial Inset Patellar - Cemented Ø 23 - Plastic	2-0205223	1
10	Trial Inset Patellar - Cemented Ø 26 - Plastic	2-0205226	1
11	Trial Inset Patellar - Cemented Ø 29 - Plastic	2-0205229	1
12	Clamp for Locking Ring	2-0104600	1
13	Trial Inset Patellar - Cementless Ø 29 - Plastic	2-0216929	1
14	Trial Inset Patellar - Cementless Ø 26 - Plastic	2-0216926	1
15	Trial Inset Patellar - Cementless Ø 23 - Plastic	2-0216923	1

# Instrumentation

**OPTION: ANATOMIC – Tibial trials thickness 18/20**

**2-02999156**

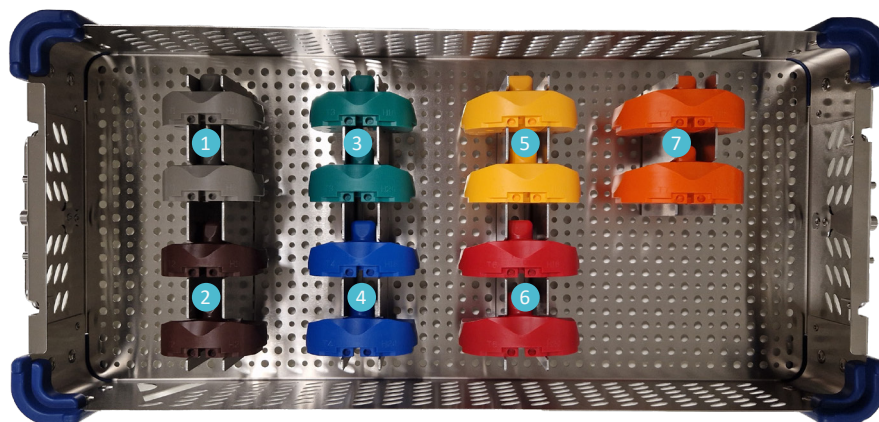

Item	Name	Product N°	Qty
1	ANATOMIC Trial fixed bearing insert, PS - Size 1, Height 18 mm	2-0230614	1
1	ANATOMIC Trial fixed bearing insert, PS - Size 1, Height 20 mm	2-0230615	1
2	ANATOMIC Trial fixed bearing insert, PS - Size 2, Height 18 mm	2-0230624	1
2	ANATOMIC Trial fixed bearing insert, PS - Size 2, Height 20 mm	2-0230625	1
3	ANATOMIC Trial fixed bearing insert, PS - Size 3, Height 18 mm	2-0230634	1
3	ANATOMIC Trial fixed bearing insert, PS - Size 3, Height 20 mm	2-0230635	1
4	ANATOMIC Trial fixed bearing insert, PS - Size 4, Height 18 mm	2-0230644	1
4	ANATOMIC Trial fixed bearing insert, PS - Size 4, Height 20 mm	2-0230645	1
5	ANATOMIC Trial fixed bearing insert, PS - Size 5, Height 18 mm	2-0230654	1
5	ANATOMIC Trial fixed bearing insert, PS - Size 5, Height 20 mm	2-0230655	1
6	ANATOMIC Trial fixed bearing insert, PS - Size 6, Height 18 mm	2-0230664	1
6	ANATOMIC Trial fixed bearing insert, PS - Size 6, Height 20 mm	2-0230665	1
7	ANATOMIC Trial fixed bearing insert, PS - Size 7, Height 18 mm	2-0230674	1
7	ANATOMIC Trial fixed bearing insert, PS - Size 7, Height 20 mm	2-0230675	1
<b>OPTION</b>	ANATOMIC Trial fixed bearing insert, PS - Slide - Size 1, Height 18 mm	2-0253214	1
<b>OPTION</b>	ANATOMIC Trial fixed bearing insert, PS - Slide - Size 1, Height 20 mm	2-0253215	1
<b>OPTION</b>	ANATOMIC Trial fixed bearing insert, PS - Slide - Size 2, Height 18 mm	2-0253224	1
<b>OPTION</b>	ANATOMIC Trial fixed bearing insert, PS - Slide - Size 2, Height 20 mm	2-0253225	1
<b>OPTION</b>	ANATOMIC Trial fixed bearing insert, PS - Slide - Size 3, Height 18 mm	2-0253234	1
<b>OPTION</b>	ANATOMIC Trial fixed bearing insert, PS - Slide - Size 3, Height 20 mm	2-0253235	1
<b>OPTION</b>	ANATOMIC Trial fixed bearing insert, PS - Slide - Size 4, Height 18 mm	2-0253244	1
<b>OPTION</b>	ANATOMIC Trial fixed bearing insert, PS - Slide - Size 4, Height 20 mm	2-0253245	1
<b>OPTION</b>	ANATOMIC Trial fixed bearing insert, PS - Slide - Size 5, Height 18 mm	2-0253254	1
<b>OPTION</b>	ANATOMIC Trial fixed bearing insert, PS - Slide - Size 5, Height 20 mm	2-0253255	1
<b>OPTION</b>	ANATOMIC Trial fixed bearing insert, PS - Slide - Size 6, Height 18 mm	2-0253264	1
<b>OPTION</b>	ANATOMIC Trial fixed bearing insert, PS - Slide - Size 6, Height 20 mm	2-0253265	1
<b>OPTION</b>	ANATOMIC Trial fixed bearing insert, PS - Slide - Size 7, Height 18 mm	2-0253274	1
<b>OPTION</b>	ANATOMIC Trial fixed bearing insert, PS - Slide - Size 7, Height 20 mm	2-0253275	1

# Instrumentation

OPTION: ANATOMIC - Size 0 Femur + Tibia

2-02999157

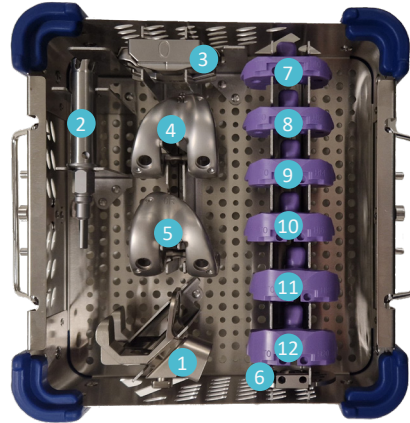

Item	Name	Product N°	Qty
1	Femoral preparation guide Size 0	2-0230700	1
2	Notch reamer Size 0	2-0231300	1
<b>SUBSTITUTE</b>	HALL notch reamer Size 0	2-0245900	1
3	4-in-1 Cutting Block Size 0	2-0255100	1
4	ANATOMIC Trial femoral component posterior stabilized left Size 0	2-0231200	1
5	ANATOMIC Trial femoral component posterior stabilized right Size 0	2-0231100	1
6	ANATOMIC Trial baseplate posterior stabilized Size 0	2-0231000	1
7	ANATOMIC Trial fixed bearing insert, PS - Size 0, Height 10 mm	2-0230601	1
8	ANATOMIC Trial fixed bearing insert, PS - Size 0, Height 12 mm	2-0230602	1
9	ANATOMIC Trial fixed bearing insert, PS - Size 0, Height 14 mm	2-0230603	1
10	ANATOMIC Trial fixed bearing insert, PS - Size 0, Height 16 mm	2-0230604	1
11	ANATOMIC Trial fixed bearing insert, PS - Size 0, Height 18 mm	2-0230605	1
12	ANATOMIC Trial fixed bearing insert, PS - Size 0, Height 20 mm	2-0230606	1
<b>SUBSTITUTE</b>	ANATOMIC Trial fixed bearing insert, PS - Slide - Size 0, Height 10 mm	2-0253200	1
<b>SUBSTITUTE</b>	ANATOMIC Trial fixed bearing insert, PS - Slide - Size 0, Height 12 mm	2-0253201	1
<b>SUBSTITUTE</b>	ANATOMIC Trial fixed bearing insert, PS - Slide - Size 0, Height 14 mm	2-0253202	1
<b>SUBSTITUTE</b>	ANATOMIC Trial fixed bearing insert, PS - Slide - Size 0, Height 16 mm	2-0253203	1
<b>SUBSTITUTE</b>	ANATOMIC Trial fixed bearing insert, PS - Slide - Size 0, Height 18 mm	2-0253204	1
<b>SUBSTITUTE</b>	ANATOMIC Trial fixed bearing insert, PS - Slide - Size 0, Height 20 mm	2-0253205	1

# Instrumentation

OPTION: ANATOMIC - Size 8 Femur + Tibia

2-02999158

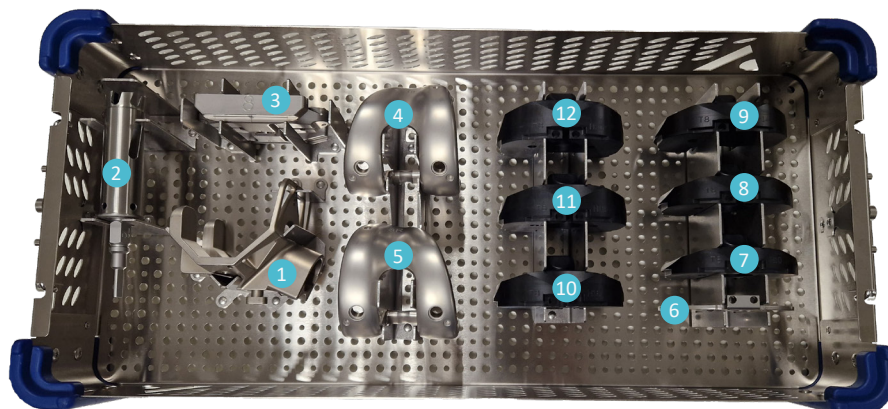

Item	Name	Product N°	Qty
1	Femoral preparation guide Size 8	2-0230708	1
2	Notch reamer Size 8	2-0231308	1
<b>SUBSTITUTE</b>	HALL notch reamer Size 8	2-0245908	1
3	4-in-1 Cutting Block Size 8	2-0255108	1
4	ANATOMIC Trial femoral component posterior stabilized left Size 8	2-0231208	1
5	ANATOMIC Trial femoral component posterior stabilized right Size 8	2-0231108	1
6	ANATOMIC Trial baseplate posterior stabilized Size 8	2-0231008	1
7	ANATOMIC Trial fixed bearing insert, PS - Size 8, Height 10 mm	2-0230680	1
8	ANATOMIC Trial fixed bearing insert, PS - Size 8, Height 12 mm	2-0230681	1
9	ANATOMIC Trial fixed bearing insert, PS - Size 8, Height 14 mm	2-0230682	1
10	ANATOMIC Trial fixed bearing insert, PS - Size 8, Height 16 mm	2-0230683	1
11	ANATOMIC Trial fixed bearing insert, PS - Size 8, Height 18 mm	2-0230684	1
12	ANATOMIC Trial fixed bearing insert, PS - Size 8, Height 20 mm	2-0230685	1
<b>SUBSTITUTE</b>	ANATOMIC Trial fixed bearing insert, PS - Slide - Size 8, Height 10 mm	2-0253280	1
<b>SUBSTITUTE</b>	ANATOMIC Trial fixed bearing insert, PS - Slide - Size 8, Height 12 mm	2-0253281	1
<b>SUBSTITUTE</b>	ANATOMIC Trial fixed bearing insert, PS - Slide - Size 8, Height 14 mm	2-0253282	1
<b>SUBSTITUTE</b>	ANATOMIC Trial fixed bearing insert, PS - Slide - Size 8, Height 16 mm	2-0253283	1
<b>SUBSTITUTE</b>	ANATOMIC Trial fixed bearing insert, PS - Slide - Size 8, Height 18 mm	2-0253284	1
<b>SUBSTITUTE</b>	ANATOMIC Trial fixed bearing insert, PS - Slide - Size 8, Height 20 mm	2-0253285	1

# Instrumentation

OPTION: TKA LOAN OPTION Conv - iIMAGE - CAS

2-02999137

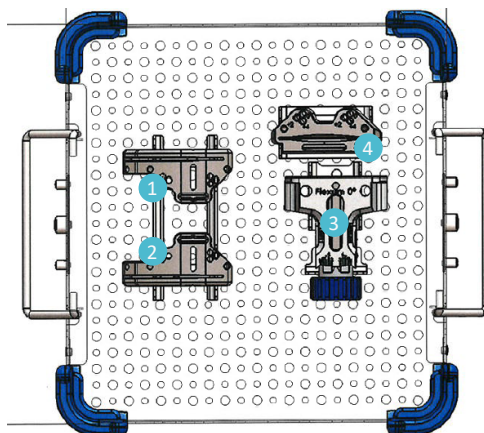

Item	Name	Product N°	Qty
1	4T tibial resection guide left - 0°	2-0236400	1
2	4T Tibial resection guide right - 0°	2-0236401	1
3	Femoral Valgus Alignment Guide 0°	2-0226600	1
4	Distal Cutting Block 8 mm - Clip System	2-1200500	1

# Instrumentation

**OPTION: Knee Ligament Balancer**

**2-02999144**

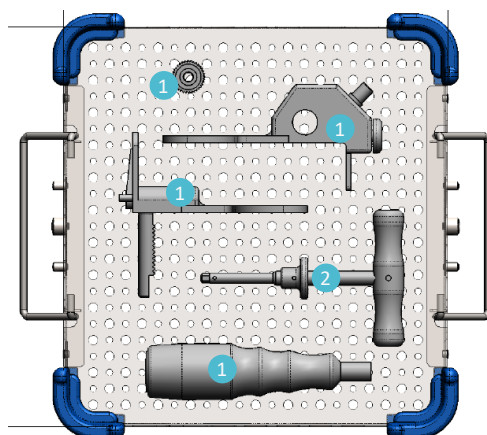

Item	Name	Product N°	Qty
1	Extra-articular ligament balancer V2	2-0233200	1
2	Snap screwdriver H5	2-0233100	1

# Instrumentation

## Large saw blades

**SYNTHES AO / SODEM large Sawblade**  
Sterile Product No. 2-0227901



**STRYKER large Sawblade**  
Sterile Product No. 2-0227902

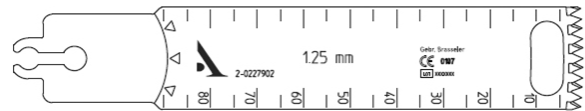

**ZIMMER / HALL / LINVATEC large Sawblade**  
Sterile Product No. 2-0227903

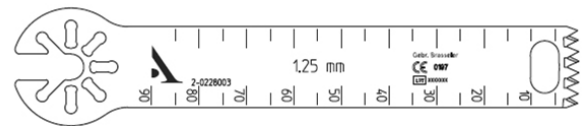

## Medium saw blades

**SYNTHES AO / SODEM medium Sawblade**  
Sterile Product No. 2-0228001

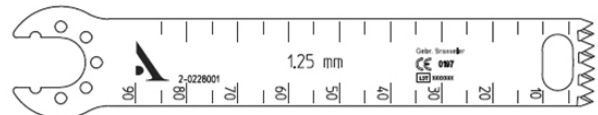

**STRYKER medium Sawblade**  
Sterile Product No. 2-0228002

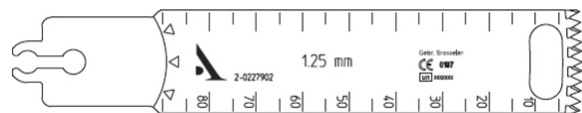

**ZIMMER / HALL / LINVATEC medium Sawblade**  
Sterile Product No. 2-0228003











**Service Clients – France :**

Porte du Grand Lyon,  
01700 Neyron – France  
Tél. : **+33 (0)4 37 85 19 19**  
Fax : +33 (0)4 37 85 19 18  
E-mail : [amplitude@amplitude-ortho.com](mailto:amplitude@amplitude-ortho.com)

**Customer Service – Export :**

11, cours Jacques Offenbach,  
ZA Mozart 2,  
26000 Valence – France  
Tél. : **+33 (0)4 75 41 87 41**  
Fax : +33 (0)4 75 41 87 42

[www.amplitude-ortho.com](http://www.amplitude-ortho.com)



<https://eifu.amplitude-ortho.com>

Reference: TO.G.051/EN/E