



Supplement to Surgical Technique

Patient-Specific knee instrumentation

For primary TKA
CT-scan version

Introduction

- This Surgical Technique Supplement describes the use of patient-matched CT i.M.A.G.E. Pin Positioners for implanting Amplitude’s primary Total Knee Arthroplasty (TKA) systems.
- It replaces the following paragraphs in the conventional Surgical Technique documents:
 - For the ANATOMIC TKA with 4-in-1 instrumentation: **TO.G.002**
From the “Femoral aiming system” paragraph to the “Tibial cut” paragraph.
 - For the SCORE & SCORE II TKA with 4-in-1 instrumentation: **TO.G.009**
From the “Femoral aiming system” paragraph to the “Tibial cut” paragraph.
 - For the ANATOMIC TKA with 5-in-1 instrumentation: **TO.G.001**
From the “Intramedullary tibial system” paragraph to the “Femoral cuts : 1 - Pins insertion” paragraph.
 - For the SCORE & SCORE II TKA with 5-in-1 instrumentation: **TO.G.008**
From the “Intramedullary tibial system” paragraph to the “Femoral cuts : 1 - Pins insertion” paragraph.

Table of contents

Introduction.....	2
Table of contents	3
General description	4
i.M.A.G.E. Process steps	6
Preoperative planning	8
Recommendations	9
Summary of the surgical technique	
Tibial technique.....	10
Femoral technique: 4-in-1 Option	11
Femoral technique: 5-in-1 Option	12
Surgical steps description	
Tibial technique.....	14
Femoral technique: 4-in-1 Option	16
Femoral technique: 5-in-1 Option	22
Instrumentation.....	25



General description

- ▶ Single-use Pin Positioners based on the patient's anatomy and the 3D preoperative plan.
- ▶ Instrumentation manufactured based on the patient's CT-scan
- ▶ It allows intraoperative check of:
 - contact areas comparing with bone models
 - femoral rotation
 - anterior femoral cut
 - tibial cut orientation

Tibia

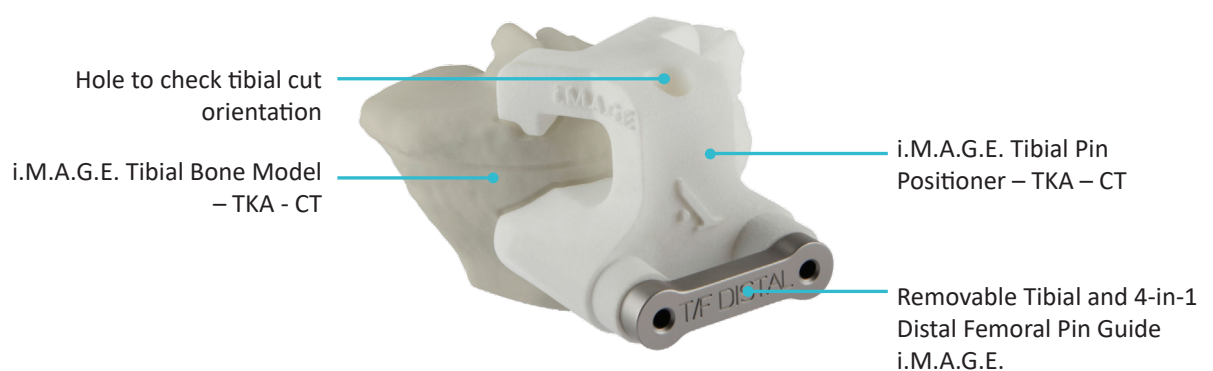

General description

Femur 4-in-1



Femur 5-in-1

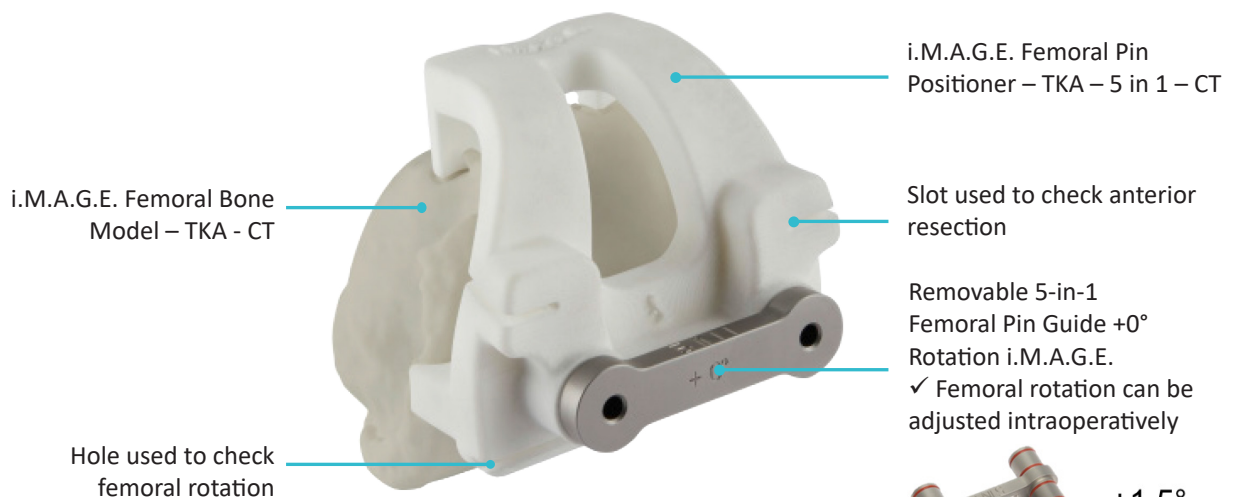

i.M.A.G.E. Process steps

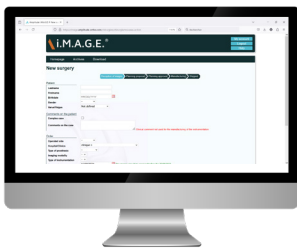

1

Online ordering

<https://image.amplitude-ortho.com/>



2

CT-scan exam

Performed using Amplitude's protocol. DICOM files sent to Amplitude.

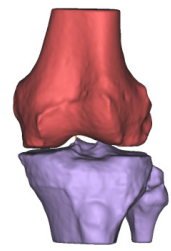

3

Image processing

Segmentation. Anatomical landmarks.



i.M.A.G.E. Process steps



4

3D planning

Performed using the i.M.A.G.E. planning software



5

Manufacturing

Design of 3D model of Pin Positioners
Manufactured by Selective Laser Sintering.



6

Delivery

Instrumentation delivered to hospital
Decontamination and sterilisation.



Preoperative planning



- The i.M.A.G.E. planning software is used to determine the size and position of the AMPLITUDE primary TKA implants before the procedure.
- The following parameters can be adjusted in the software :
 - On the femur :
 - Femoral component size
 - Anterior/posterior position
 - Flexum/recurvatum
 - Internal/external rotation
 - Height of distal cut
 - Medial/lateral positioning
 - Varus/valgus positioning
 - For the tibia :
 - Anterior/posterior slope
 - Height of tibial cut
 - Anterior/posterior position
 - Medial/lateral positioning
 - Varus/valgus positioning
 - Internal/external rotation
- Changing these parameters will update in real-time the 3D bone model generated based on the patient's MRI images.
- The planning software, instructions for its use and imaging protocols can be downloaded from <https://image.amplitude-ortho.com>. Please contact your Amplitude sales rep for access.



Recommendations

- ▶ We do not recommend using this system in patients who have an existing implant near the support surfaces of the device such as an osteotomy plate, nail, staple, screw, etc. This could induce artefacts that could alter the quality of the CT-scan images.
- ▶ Before starting the procedure, make sure the patient-specific data on each Pin Positioner and Bone Model is correct. Do not use these items if the patient identification is not clearly visible.
- ▶ Example of patient identification: 0000001-F-SUR-X-PN
 - 0000001: 7-digit number
 - F: first letter of patient's first name
 - SUR: first 3 letters of patient's surname
 - X: operated side, left (L) or right (R)
 - PN: surgeon's initials
- ▶ **Do not resect any of the osteophytes** because they are needed to position the Pin Positioners.
- ▶ If an osteophyte that is not under a contact point interferes with exact placement of the Pin Positioner, remove the osteophyte in question and try again to set the Pin Positioner in place.
- ▶ The surgeon can start with either the tibial cut or the femoral cuts.

REMINDER

The purpose of this surgical technique description is to provide instructions on how to use the instrumentation properly. The surgeon is fully responsible for choosing and performing the approach and surgical technique.



Summary of the surgical technique

Tibial technique

1

Placement of i.M.A.G.E. Tibial Pin Positioner – TKA – CT

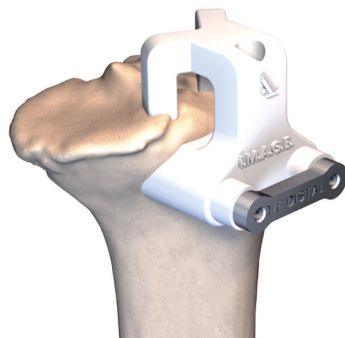

2

Insertion of tibial Pins

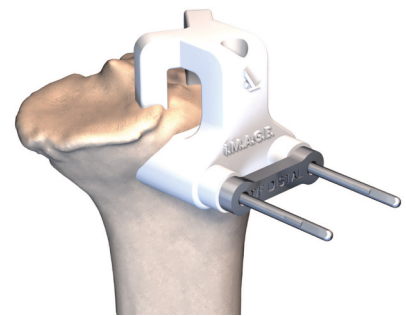

3

Tibial cut

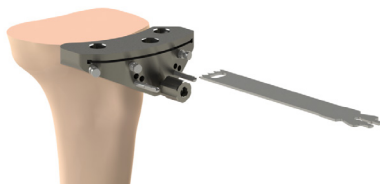

4

Flexion and extension gaps

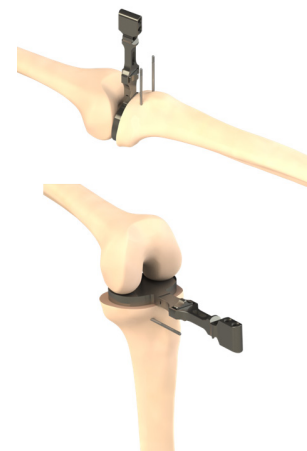

Summary of the surgical technique

Femoral technique: 4-in-1 Option

1

Placement of
i.M.A.G.E. Femoral Pin
Positioner – TKA – 4 in 1 – CT

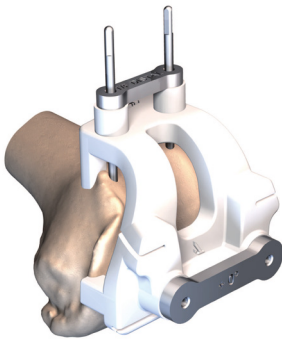

2

Insertion of femoral Pins

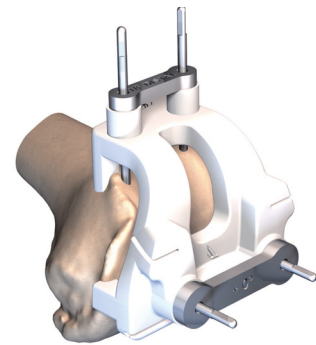

3

Distal femoral cut

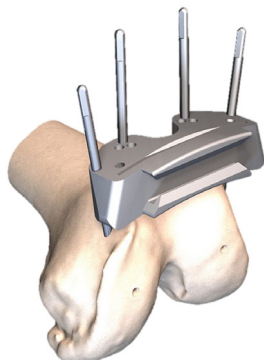

4

4 in 1 femoral cuts

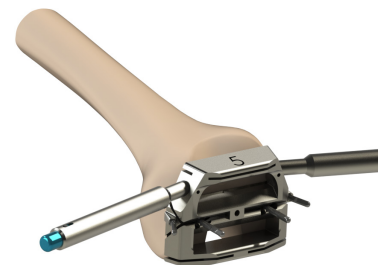

Summary of the surgical technique

Femoral technique: 5-in-1 Option

1

Placement of i.M.A.G.E.
Femoral Pin Positioner – TKA –
5 in 1 – CT

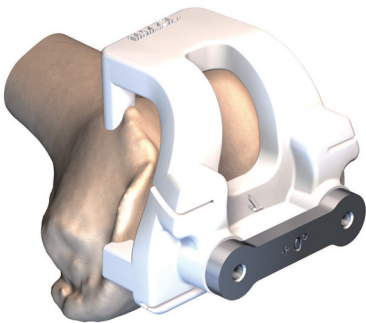

2

Insertion of femoral Pins

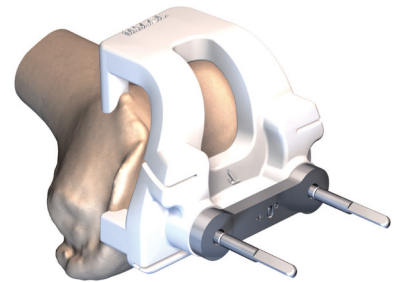

3

5-in-1 femoral cuts

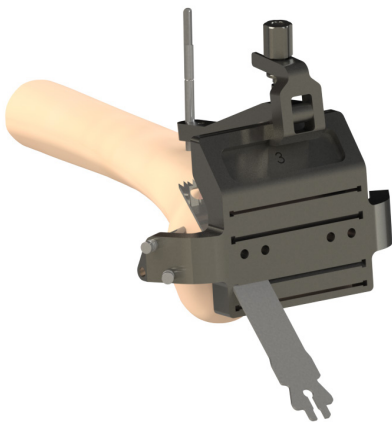

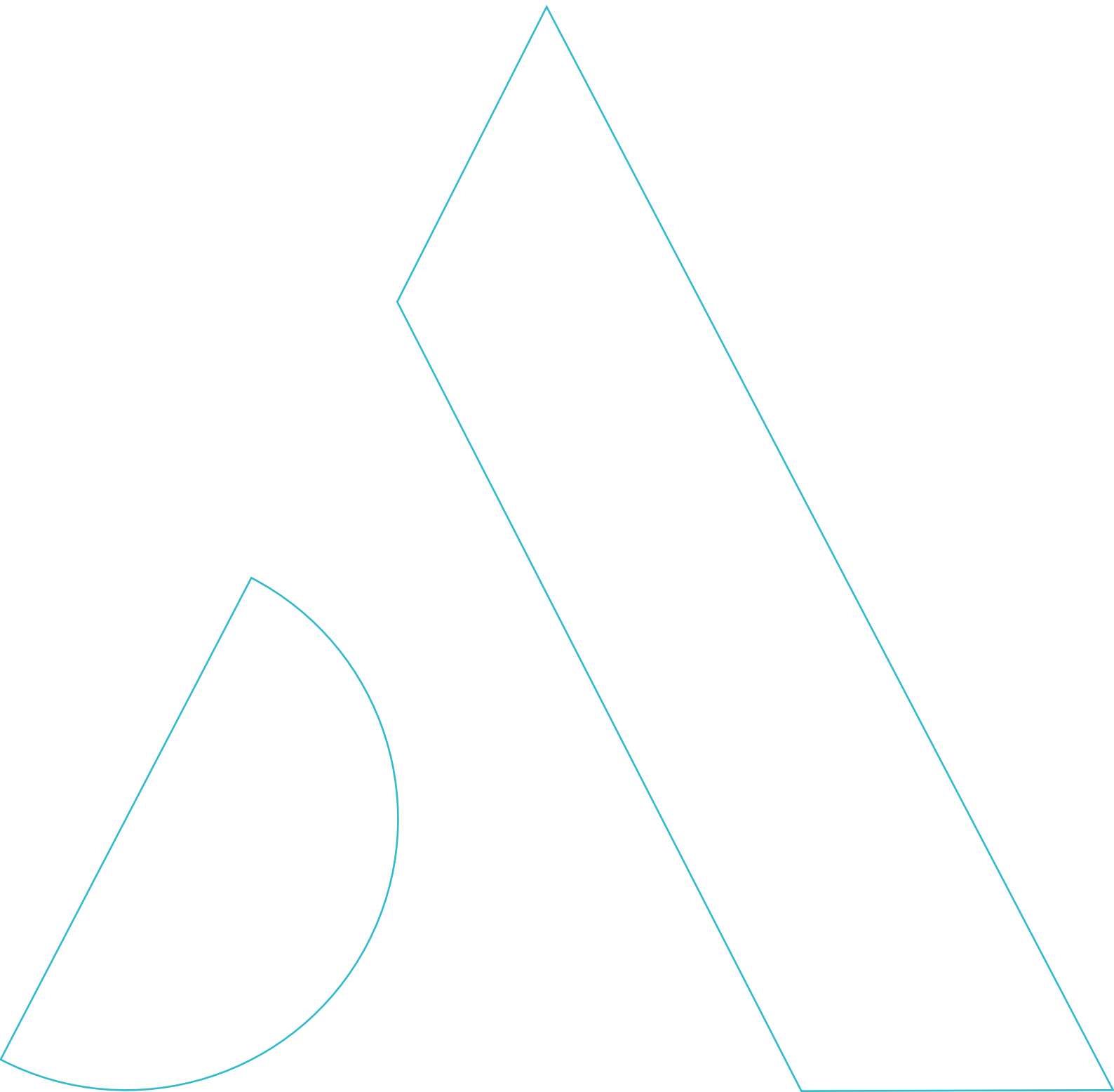

Tibial technique

Insertion of tibial pins

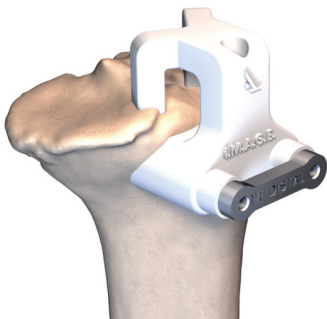

- ▶ Hyperflex the knee and dislocate the tibia forward.
- ▶ Use the i.M.A.G.E. Tibial Bone Model – TKA - CT to locate the contact areas on the tibia and make sure they are not covered by fibrous tissue.
- ▶ Set the i.M.A.G.E. Removable Tibial and 4-in-1 Distal Femoral Pin Guide on the i.M.A.G.E. Tibial Pin Positioner – TKA – CT.
- ▶ Place both components on the proximal tibia.
- ▶ Make sure the i.M.A.G.E. Tibial Pin Positioner – TKA – CT is stable (unique position) and rests against the anterior tibia.

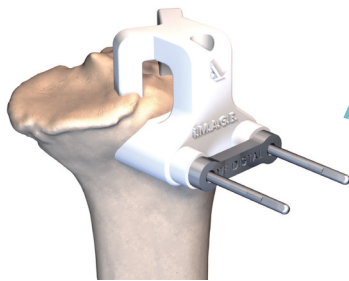

- ▶ Insert 2 Headless pins length 80 mm into the i.M.A.G.E. Removable Tibial and 4-in-1 Distal Femoral Pin Guide using the Motorised Hand-piece (with Universal or AO quick release adaptor for pin), while holding the i.M.A.G.E. Tibial Pin Positioner – TKA – CT firmly in place (if needed, the Pin holes can be pre-drilled with the Long Drill bit $\varnothing 3.2$ length 145 mm).

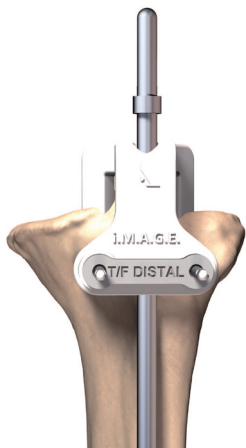

- ▶ Check the tibial cut orientation (varus/valgus and slope) by inserting the Extra medullary alignment rod in the hole on the i.M.A.G.E. Tibial Pin Positioner – TKA – CT.

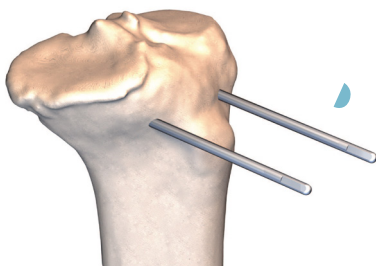

- ▶ Remove the i.M.A.G.E. Removable Tibial and 4-in-1 Distal Femoral Pin Guide and then the i.M.A.G.E. Tibial Pin Positioner – TKA – CT.

Tibial technique

Tibial cut and gaps check

- Place the Tibial resection guide (right or left) on the Headless pins length 80 mm in the 0 position and make sure it is flush with the anterior tibial cortex.

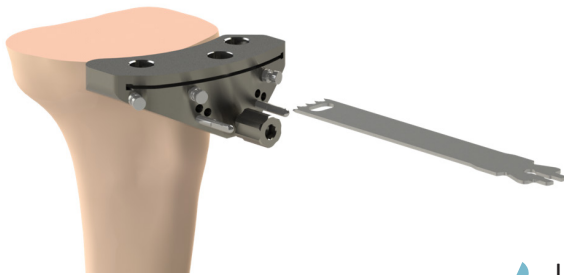

NOTE

At this point, two checks can be performed :

- The resection height can be checked using the Tibial stylus or the Resection gauge.
- The tibial mechanical axis can be checked with the Alignment gauge and Extramedullary alignment rod.

- Use 3 converging Headed pins - length 70 mm to stabilise the Tibial resection guide.
- Perform the tibial cut.
- Remove the Headed pins - length 70 mm using the Pin extractor.
- Slide the Tibial resection guide off the Headless pins length 80 mm but leave the them in place in case recutting is required (the +2 and +4 holes will be used at that time).

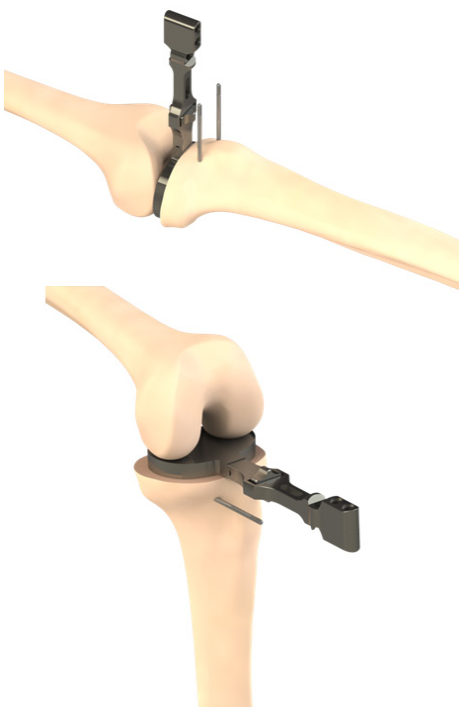

NOTE

If the cortex is fragile, the Long Drill bit $\varnothing 3.2$ length 145 mm can be used to make pilot holes for the Headed pins - length 70 mm.

- At this point, the gaps can be checked with a Spacer thickness 10 mm mounted on the Universal handle; the Extramedullary alignment rods can be assembled with this Handle.
- The Spacer thickness 2 mm or 4 mm for spacer can be added to the Spacer thickness 10 mm to further refine ligament tension.



Femoral technique: 4-in-1 Option

Placement of the 4-in-1 femoral pin positioner

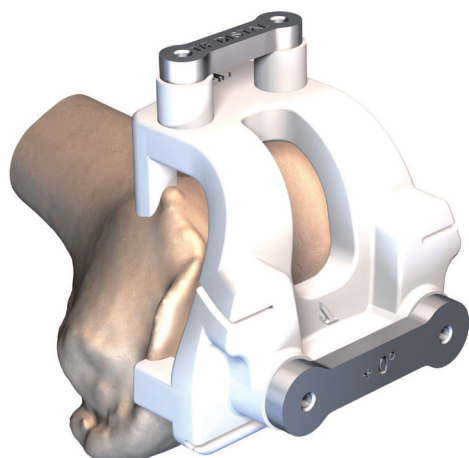

- Flex the knee 90°.
- Use the i.M.A.G.E. Femoral Bone Model – TKA - CT to locate the contact areas on the femur and make sure they are not covered by fibrous tissue.
- Expose the femur in the frontal plane.
- Place the Removable Tibial and 4-in-1 Distal Femoral Pin Guide i.M.A.G.E. in the anterior holes of the i.M.A.G.E. Femoral Pin Positioner – TKA – 4 in 1 – CT.
- Place the Removable 4-in-1 Femoral Pin Guide +0° Rotation i.M.A.G.E. in the distal holes of the i.M.A.G.E. Femoral Pin Positioner – TKA – 4 in 1 – CT.
- Place these components on the anterior and distal femur.
- Make sure the i.M.A.G.E. Femoral Pin Positioner – TKA – 4 in 1 – CT is stable (unique position).



NOTE

After determining the flexion gaps, an additional external rotation of 1.5°, 3° or 4.5° can be added to the planned rotation. To do this, remove the Removable 4-in-1 Femoral Pin Guide +0° Rotation i.M.A.G.E. and replace it with the Removable 4-in-1 Femoral Pin Guide +1.5°, +3° or +4.5° Rotation i.M.A.G.E. (make sure to see the «RIGHT» marking on the right knee and the «LEFT» marking on the left knee).

Femoral technique: 4-in-1 Option

Placement of femoral pins

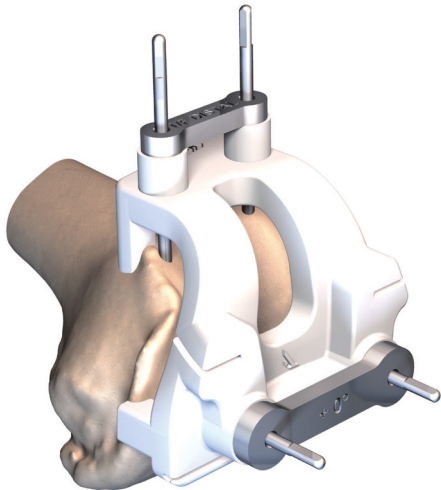

- Insert 2 Headless pins \varnothing 3.2 Length 65 mm into the Removable Tibial and 4-in-1 Distal Femoral Pin Guide i.M.A.G.E. using the Motorised Hand-piece (with Universal or AO quick release adaptor for pin), while holding the i.M.A.G.E. Femoral Pin Positioner – TKA – 4 in 1 – MRI firmly in place (if needed, the Pin holes can be pre-drilled with the Long Drill bit \varnothing 3.2 length 145 mm).
- If the four other cuts will be made using the i.M.A.G.E. system, insert 2 Headless pins \varnothing 3.2 Length 65 mm distally, while holding the i.M.A.G.E. Femoral Pin Positioner – TKA – 4 in 1 – CT firmly in place and making sure it is stable.
- Check the anterior resection using the Resection gauge and check the external rotation using the Alignment Pin \varnothing 2 Length 150 mm.

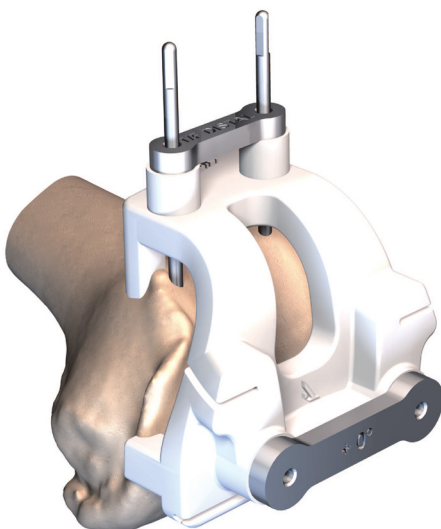
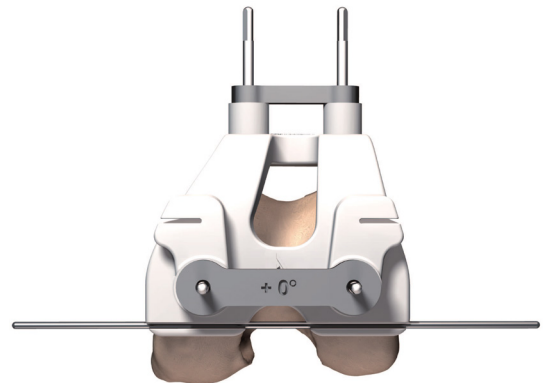
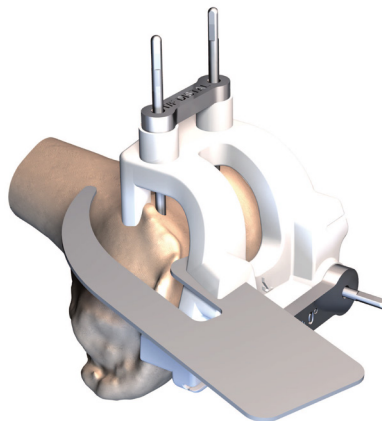

- Remove the Removable 4-in-1 Femoral Pin Guide i.M.A.G.E. and the distal Headless pins \varnothing 3.2 Length 65 mm
- Remove the Removable Tibial and 4-in-1 Distal Femoral Pin Guide i.M.A.G.E. and then the i.M.A.G.E. Femoral Pin Positioner – TKA – 4 in 1 – CT

Femoral technique: 4-in-1 Option

Distal Femoral cut

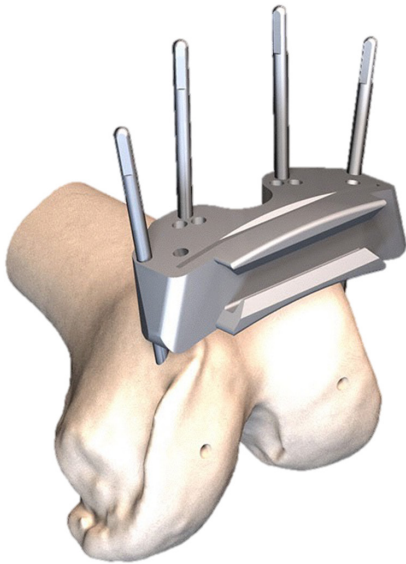

- ▶ Place the Distal Resection Guide 8 mm on the Headless pins \varnothing 3.2 Length 65 mm in the 0 position, against the femoral trochlea.
- ▶ Check the cut thickness with the Resection gauge.
- ▶ Use 2 other converging Headless pins \varnothing 3.2 Length 65 mm to stabilise the Distal Resection Guide 8 mm.

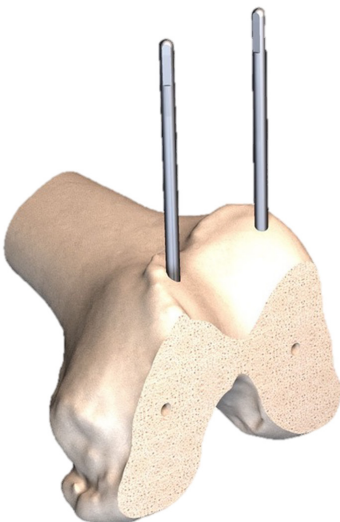

- ▶ Perform the distal cut using a Medium AMPLITUDE Saw Blade that matches the Motorised Handpiece.
- ▶ Extract the converging Headless pins \varnothing 3.2 Length 65 mm with the Motorised Hand-piece or Pin extractor.
- ▶ Slide the Distal Resection Guide 8 mm off the Headless pins \varnothing 3.2 Length 65 mm in the 0 holes but leave them in place in case recutting is necessary.

Femoral technique: 4-in-1 Option

4-in-1 Femoral cuts

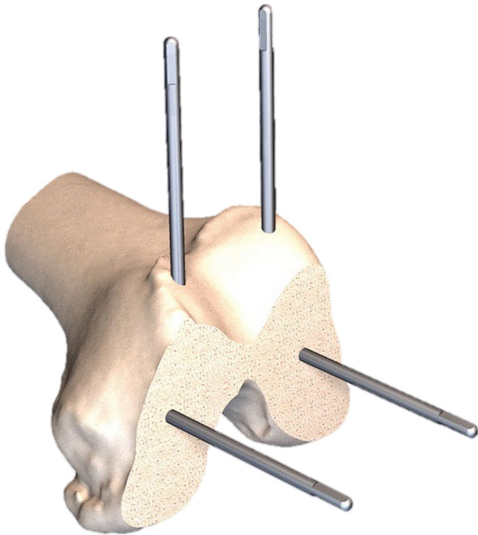

OPTION 1: Make the 4-in-1 femoral cuts WITH the i.M.A.G.E. system:

- Put the Headless pins \varnothing 3.2 Length 65 mm back in the distal holes.
- Place the 4-in-1 femoral resection guide corresponding to the planned size on the distal Headless pins \varnothing 3.2 Length 65 mm in the middle holes (neutral position).

NOTE

At this step the femoral size can still be changed. Place the chosen 4-in-1 femoral resection guide on the Headless pins \varnothing 3.2 Length 65 mm:

With a larger size, the posterior cut is unchanged but the anterior cut will be 2.6 mm smaller.

With a smaller size, the posterior cut is unchanged but the anterior cut will be 2.6 mm larger.

- Proceed with the femoral cuts and the tibial, femoral and patellar preparation steps, and then insert the trial and chosen implants as set out in the conventional Surgical Technique documents.

- For the ANATOMIC TKA: TO.G.002:

From the "Femoral cuts: 2– Femoral cuts" paragraph to the "Placing definitive implants" paragraph.

- For the SCORE TKA: TO.G.009:

From the "Femoral cuts: 2– Femoral cuts" paragraph to the "Placing definitive implants" paragraph.

- For the SCORE II TKA: TO.G.009:

From the "Femoral cuts: 2– Femoral cuts" paragraph to the "Placing definitive implants" paragraph replacing the paragraphs «Femoral preparation» and «Tibial plateau preparation» with those of TO.G.013.



Femoral technique: 4 in 1 Option

4 in 1 Femoral cuts

OPTION 2: Make the 4-in-1 femoral cuts WITHOUT the i.M.A.G.E. system:

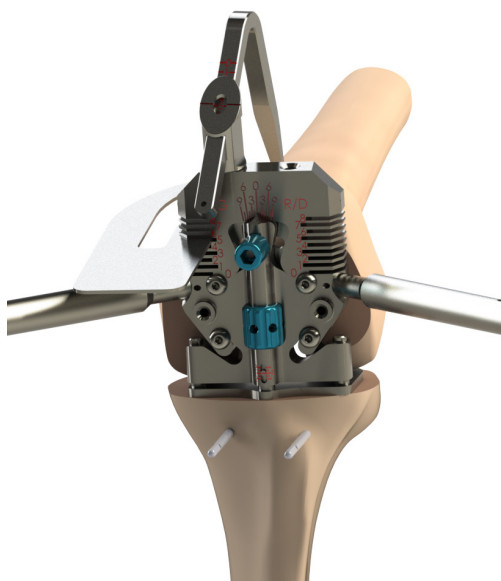

- Position the distal Headless pins \varnothing 3.2 Length 65 mm using the Extra-articular ligament balancer V2 and the 4-in-1 pin positioner as set out in the conventional Surgical Technique document.

- For the ANATOMIC TKA: **TO.G.002:**

The paragraphs “Extension and flexion gaps” / “Femoral cuts: 1 - Distal pin insertion”.

- For the SCORE & SCORE II TKA: **TO.G.009:**

The paragraphs “Extension and flexion gaps” / “Femoral cuts: 1 - Distal pin insertion ».

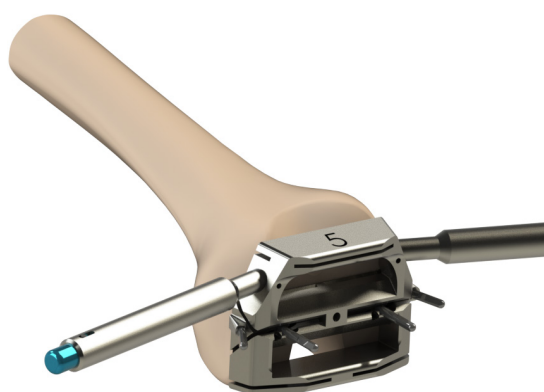

- Proceed with the femoral cuts and the tibial, femoral and patellar preparation steps, and then insert the trial and chosen implants as set out in the conventional Surgical Technique document.

- For the ANATOMIC TKA: **TO.G.002:**

From the “Femoral cuts: 2– Femoral cuts” paragraph to the “Placing definitive implants” paragraph.

- For the SCORE TKA: **TO.G.009:**

From the “Femoral cuts: 2– Femoral cuts” paragraph to the “Placing definitive implants” paragraph.

- For the SCORE II TKA: **TO.G.009:**

From the “Femoral cuts: 2– Femoral cuts” paragraph to the “Placing definitive implants” paragraph replacing the paragraphs «Femoral preparation» and «Tibial plateau preparation» with those of **TO.G.013.**

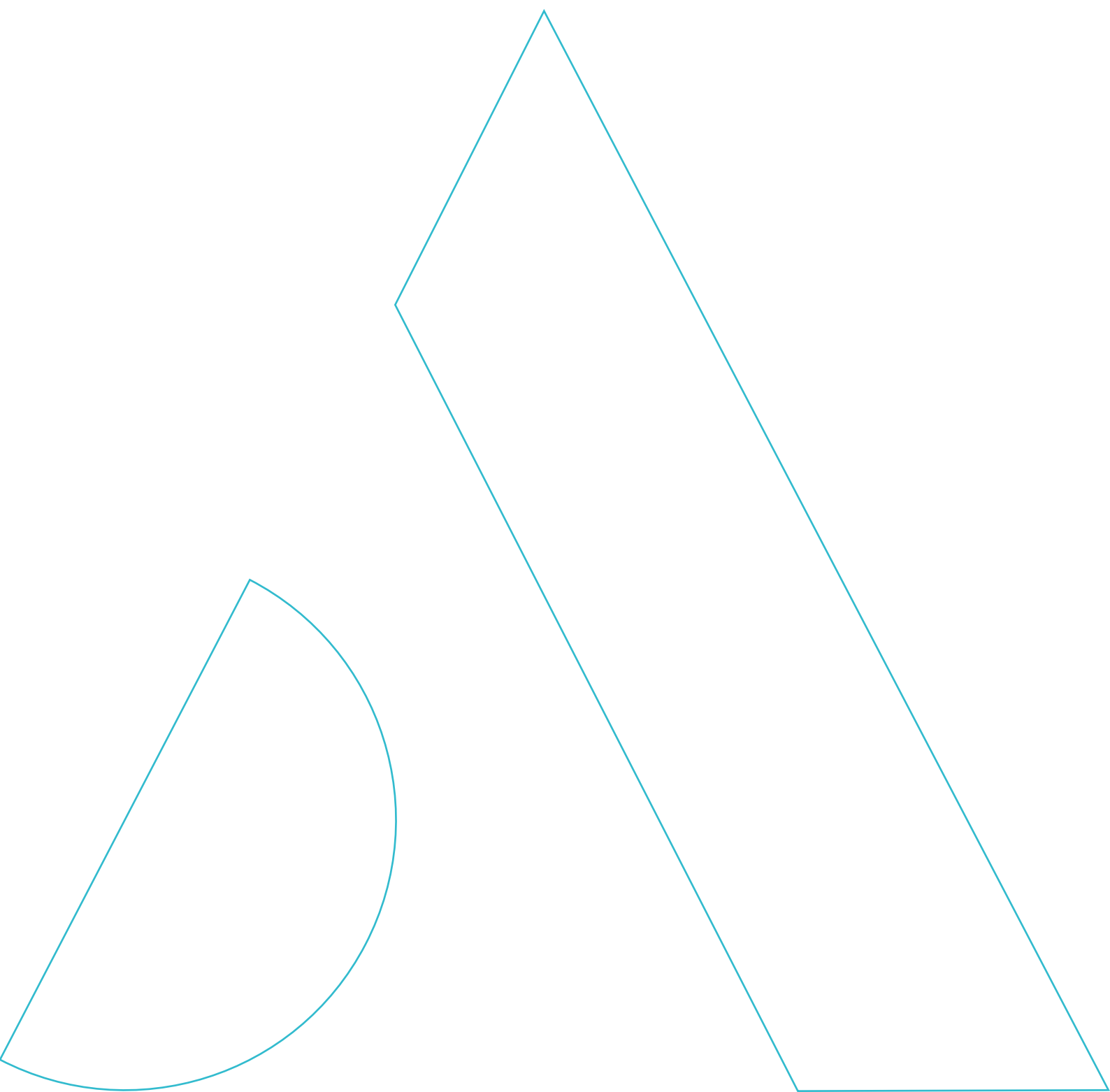

Femoral technique: 5-in-1 Option

Placement of the 5-in-1 femoral pin positioner

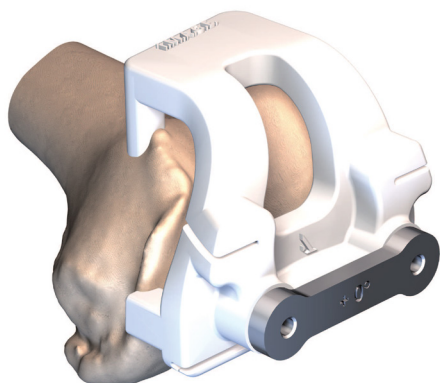

- Flex the knee 90°.
- Use the i.M.A.G.E. Femoral Bone Model – TKA - CT to locate the contact areas on the femur and make sure they are not covered by fibrous tissue.
- Expose the femur in the frontal plane.
- Place the Removable 5-in-1 Femoral Pin Guide +0° Rotation i.M.A.G.E. in the distal holes of the i.M.A.G.E. Femoral Pin Positioner – TKA – 5 in 1 – CT.
- Place these components on the anterior and distal femur.
- Make sure the i.M.A.G.E. Femoral Pin Positioner – TKA – 5 in 1 – CT is stable (unique position).



NOTE

After determining the flexion gaps, an additional external rotation of 1.5°, 3° or 4.5° can be added to the planned rotation. To do this, remove the Removable 5-in-1 Femoral Pin Guide +0° Rotation i.M.A.G.E. and replace it with the Removable 5-in-1 Femoral Pin Guide +1.5°, +3° or +4.5° Rotation i.M.A.G.E. (make sure to see the «RIGHT» marking on the right knee and the «LEFT» marking on the left knee).

Femoral technique: 5-in-1 Option

Placement of femoral pins and 5-in-1 femoral cuts

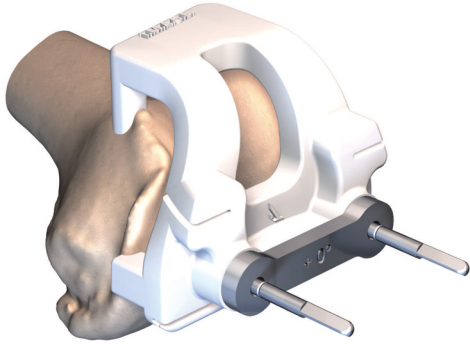

- Insert 2 Smooth Pins \varnothing 4 Length 90 mm into the Removable 5-in-1 Femoral Pin Guide i.M.A.G.E. using the Motorised Hand-piece (with Universal or AO quick release adaptor for pin), while holding the i.M.A.G.E. Femoral Pin Positioner – TKA – 5 in 1 – CT firmly in place.

- Check the anterior resection using the Resection gauge and check the external rotation using the Alignment Pin \varnothing 2 Length 150 mm.

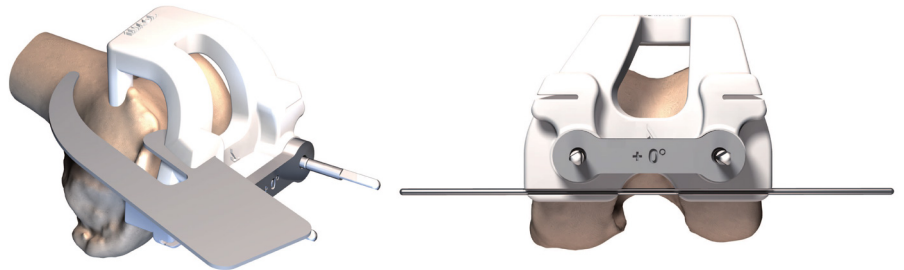

- Remove the Removable 5-in-1 Femoral Pin Guide +0° Rotation i.M.A.G.E. and then the i.M.A.G.E. Femoral Pin Positioner – TKA – 5 in 1 – CT.

- Place the Femoral resection guide corresponding to the planned size on the Smooth Pins \varnothing 4 Length 90 mm.

- Proceed with the femoral cuts and the tibial, femoral and patellar preparation steps, and then insert the trial and chosen implants as set out in the conventional Surgical Technique document :

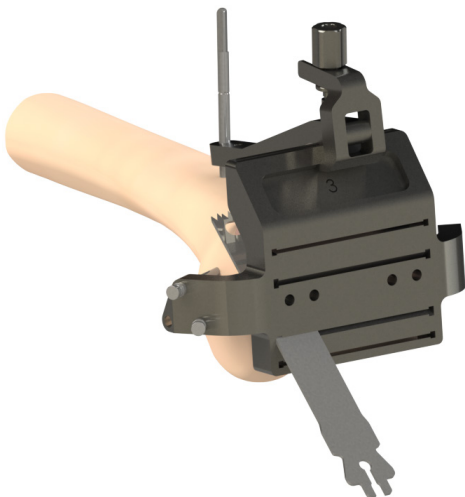

- For the ANATOMIC TKA: **TO.G.001:**

From the “Femoral cuts: 2 - Positioning of the 5-in-1 resection guide and cuts” paragraph to the “Placing definitive implants” paragraph.

- For the SCORE TKA: **TO.G.008:**

From the “Femoral cuts: 2 - Positioning of the 5-in-1 resection guide and cuts” paragraph to the “Placing definitive implants” paragraph.

- For the SCORE II TKA: **TO.G.008:**

From the “Femoral cuts: 2 - Positioning of the 5-in-1 resection guide and cuts” paragraph to the “Placing definitive implants” paragraph replacing the paragraphs «Femoral preparation» and «Tibial plateau preparation» with those of **TO.G.013**.

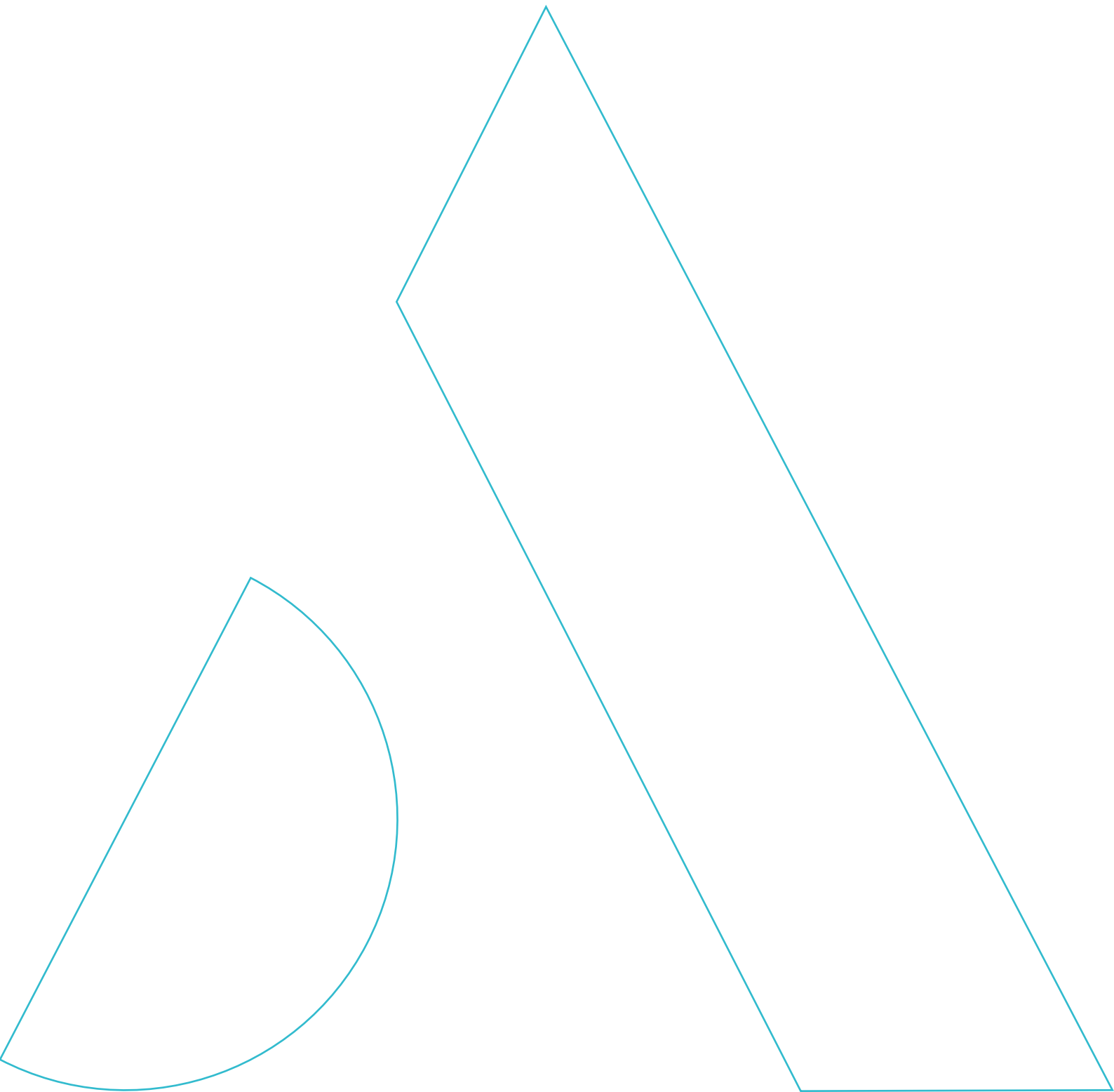

Instrumentation

The i.M.A.G.E. instrumentation for Amplitude's primary TKA implants requires:

- **An i.M.A.G.E. set CT – Pin Positioners F & T With or Without Bone Models – TKA – 4 in 1 or 5 in 1 – Non Sterile**
- **A Set for i.M.A.G.E. - TKA 4 in 1 or 5 in 1**
- **The conventional instrumentation for the specific TKA model**

The conventional instrumentation for the various TKA models is described in the following Surgical Technique documents:

- **ANATOMIC TKA with 4-in-1 instrumentation: TO.G.002**
- **SCORE TKA with 4-in-1 instrumentation: TO.G.009**
- **ANATOMIC TKA with 5-in-1 instrumentation: TO.G.001**
- **SCORE TKA with 5-in-1 instrumentation: TO.G.008**
- **SCORE II TKA with 4-in-1 and 5-in-1 instrumentation: TO.G.013**

Instrumentation

**i.M.A.G.E. set CT - Pin positioners F & T
with bone models - TKA - 4 in 1 - Non sterile**

9-0200430

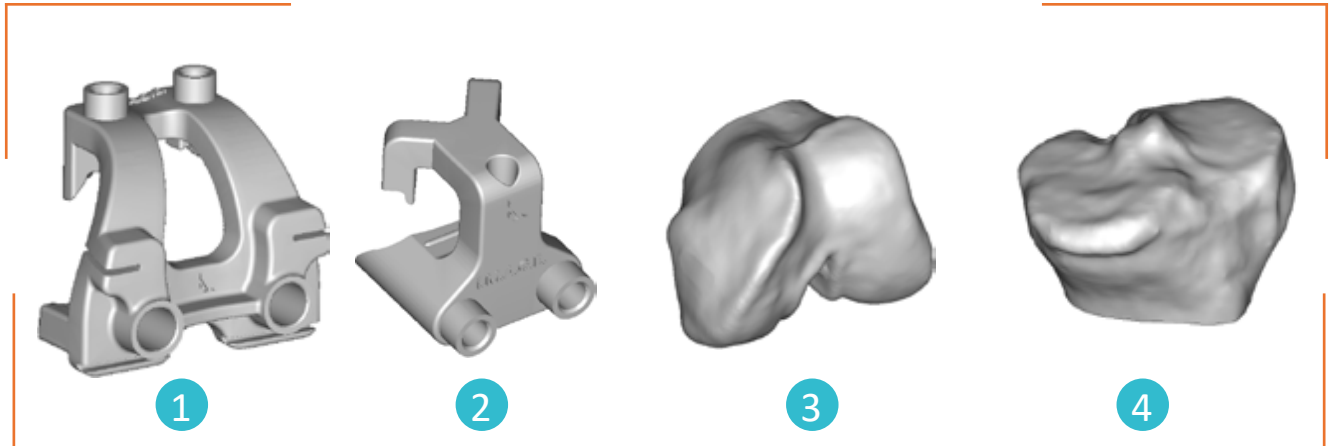

Item	Name	Product No.	Qty
1	i.M.A.G.E. Femoral Pin Positioner – TKA – 4 in 1 – CT	-	1
2	i.M.A.G.E. Tibial Pin Positioner – TKA – CT	-	1
3	i.M.A.G.E. Femoral Bone Model – TKA - CT	-	1
4	i.M.A.G.E. Tibial Bone Model – TKA - CT	-	1

**i.M.A.G.E. set CT - Pin positioners F & T
- TKA - 4 in 1 - Non sterile**

9-0200420

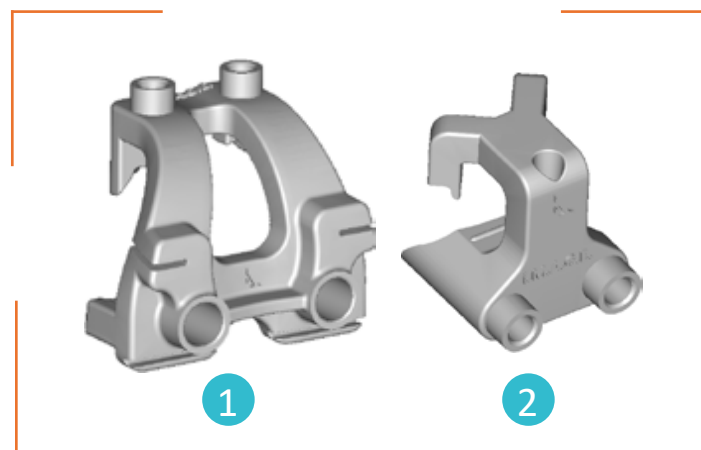

Item	Name	Product No.	Qty
1	i.M.A.G.E. Femoral Pin Positioner – TKA – 4 in 1 – CT	-	1
2	i.M.A.G.E. Tibial Pin Positioner – TKA – CT	-	1

Instrumentation

**i.M.A.G.E. set CT - Pin positioner F & T
with bone models - TKA - 5 in 1 - Non sterile**

9-0200330

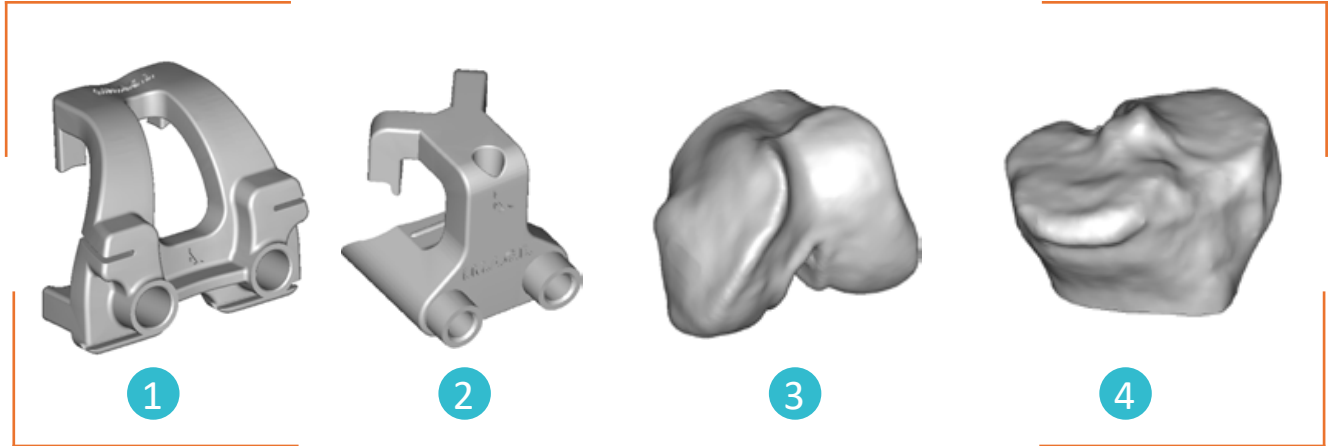

Item	Name	Product No.	Qty
1	i.M.A.G.E. Femoral Pin Positioner – TKA – 5 in 1 – CT	-	1
2	i.M.A.G.E. Tibial Pin Positioner – TKA – CT	-	1
3	i.M.A.G.E. Femoral Bone Model – TKA - CT	-	1
4	i.M.A.G.E. Tibial Bone Model – TKA - CT	-	1

**i.M.A.G.E. set CT - Pin positioner F & T
- TKA - 5 in 1 - Non sterile**

9-0200320

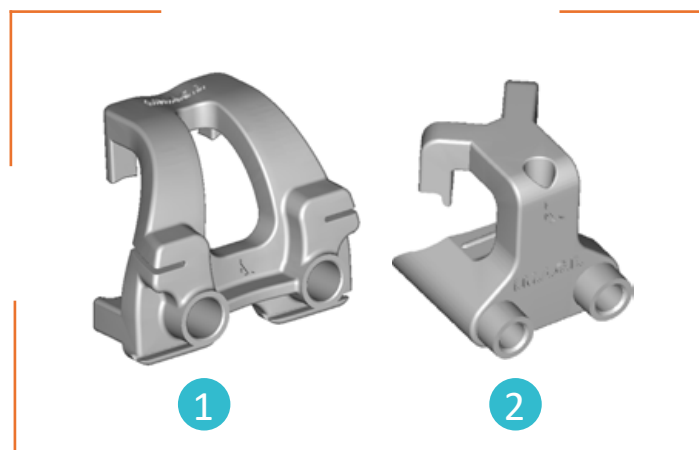

Item	Name	Product No.	Qty
1	i.M.A.G.E. Femoral Pin Positioner – TKA – 5 in 1 – CT	-	1
2	i.M.A.G.E. Tibial Pin Positioner – TKA – CT	-	1

Instrumentation

Set for i.M.A.G.E. - TKA 4 in 1

2-0299947

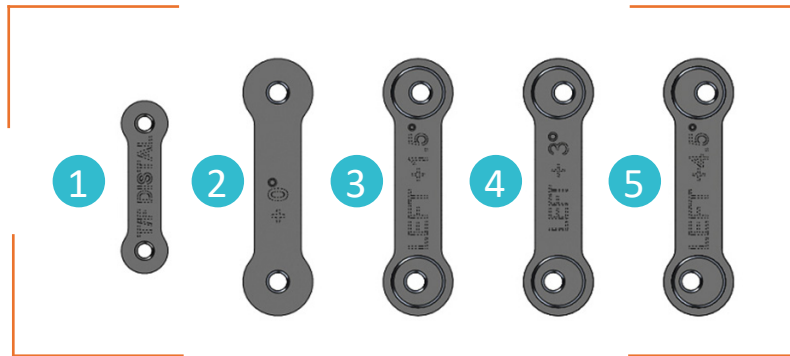

Item	Name	Product No.	Qty
1	Removable Tibial and 4-in-1 Distal Femoral Pin Guide i.M.A.G.E.	2-0228800	1
2	Removable 4-in-1 Femoral Pin Guide +0° Rotation i.M.A.G.E.	2-0228701	1
3	Removable 4-in-1 Femoral Pin Guide +1.5° Rotation i.M.A.G.E.	2-0228702	1
4	Removable 4-in-1 Femoral Pin Guide +3° Rotation i.M.A.G.E.	2-0228703	1
5	Removable 4-in-1 Femoral Pin Guide +4.5° Rotation i.M.A.G.E.	2-0228704	1

OR

Set for i.M.A.G.E. - TKA 4 in 1

2-02999123



Item	Name	Product No.	Qty
1	Removable Tibial and 4-in-1 Distal Femoral Pin Guide i.M.A.G.E.	2-0228800	1
2	Removable 4-in-1 Femoral Pin Guide +0° Rotation i.M.A.G.E.	2-0228701	1
3	Removable 4-in-1 Femoral Pin Guide +1.5° Rotation i.M.A.G.E.	2-0258002	1
4	Removable 4-in-1 Femoral Pin Guide +3° Rotation i.M.A.G.E.	2-0258003	1
5	Removable 4-in-1 Femoral Pin Guide +4.5° Rotation i.M.A.G.E.	2-0258004	1



Instrumentation

Set for i.M.A.G.E. - TKA 5 in 1

2-0299942

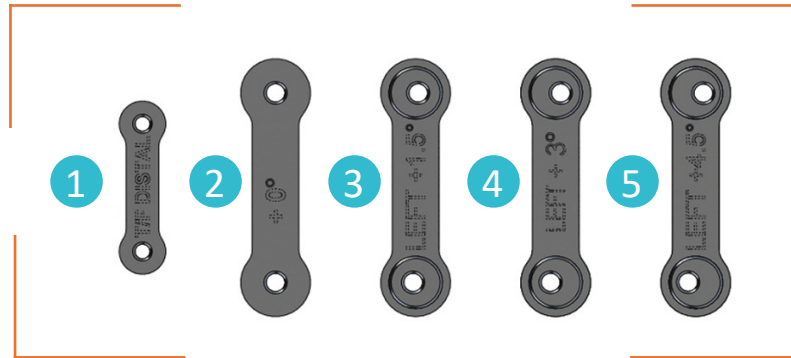

Item	Name	Product No.	Qty
1	Removable Tibial and 4-in-1 Distal Femoral Pin Guide i.M.A.G.E.	2-0228800	1
2	Removable 5-in-1 Femoral Pin Guide +0° Rotation i.M.A.G.E.	2-0228601	1
3	Removable 5-in-1 Femoral Pin Guide +1.5° Rotation i.M.A.G.E.	2-0228604	1
4	Removable 5-in-1 Femoral Pin Guide +3° Rotation i.M.A.G.E.	2-0228602	1
5	Removable 5-in-1 Femoral Pin Guide +4.5° Rotation i.M.A.G.E.	2-0228605	1

OR

Set for i.M.A.G.E. - TKA 5 in 1

2-02999122



Item	Name	Product No.	Qty
1	Removable Tibial and 4-in-1 Distal Femoral Pin Guide i.M.A.G.E.	2-0228800	1
2	Removable 5-in-1 Femoral Pin Guide +0° Rotation i.M.A.G.E.	2-0228601	1
3	Removable 5-in-1 Femoral Pin Guide +1.5° Rotation i.M.A.G.E.	2-0257904	1
4	Removable 5-in-1 Femoral Pin Guide +3° Rotation i.M.A.G.E.	2-0257902	1
5	Removable 5-in-1 Femoral Pin Guide +4.5° Rotation i.M.A.G.E.	2-0257905	1





Customer Service – France :

Porte du Grand Lyon,
01700 Neyron – France
Tél. : **+33 (0)4 37 85 19 19**
Fax : +33 (0)4 37 85 19 18
E-mail : amplitude@amplitude-ortho.com

Customer Service – Export :

11, cours Jacques Offenbach,
ZA Mozart 2,
26000 Valence – France
Tél. : **+33 (0)4 75 41 87 41**
Fax : +33 (0)4 75 41 87 42

www.amplitude-ortho.com

Reference: TO.G.033/EN/A