

# AMPLIVISION®

*Computer Assisted Surgery*



Surgical Technique  
CAS 5-in-1



## SUMMARY

INTRODUCTION .....	4
STARTING THE SOFTWARE.....	5
SURGICAL PROTOCOL SELECTION .....	7
PREPARATION PHASE .....	8
WORKSTATION INSTALLATION.....	9
CALIBRATION OF THE PROBE AND ARRAYS.....	10
TIBIAL AND FEMORAL REGISTRATIONS .....	11
TIBIAL PLANNING .....	19
TIBIAL NAVIGATION .....	21
FEMORAL PLANNING .....	24
FEMORAL NAVIGATION .....	29
TRIALS .....	33
SAVING THE SURGERY REPORT .....	38
POWERING DOWN THE WORKSTATION.....	39
INSTRUMENTATION .....	40
APPENDIX .....	43

## INTRODUCTION

This Surgical Technique Supplement describes the use of the 5-in-1 Computer-Assisted Surgery software for implanting AMPLITUDE's Total Knee Arthroplasty (TKA) systems.

It replaces the following paragraphs in the conventional Surgical Technique documents:

For the SCORE® TKA with 5-in-1 instrumentation: **TO.G.GB.021**

- From the "Intramedullary tibial aiming" to the "Combined tibial aiming" paragraph.
- From the "Flexion and extension gaps" to the "Setting up threaded pins" paragraph.
- The "Mediolateral femoral adjustment" paragraph.

For the SCORE® II TKA with 5-in-1 instrumentation: refer to the SCORE® Surgical Technique document **TO.G.GB.021** (see above bullet point), the Conventional ST SCORE II 5-in-1 **TO.G.GB.023** (4T instrumentation set) and its supplement **TO.G.GB.045**.

For the Revision SCORE® TKA used as a primary implant with the 5-in-1 instrumentation: **TO.G.GB.029**

- From the "Intramedullary tibial aiming" to the "Combined tibial aiming" paragraph.
- From the "Flexion and extension gaps" to the "Setting up pins" paragraph.
- From the "Flexion and extension trials" to the "Preparation of keel entry point" paragraph.
- From the "Tibia I plateau preparation" to the "Patella implantation" paragraph.

For the ANATOMIC® TKA with 5-in-1 instrumentation: **TO.G.GB.014**

- From the "Intramedullary tibial aiming" paragraph to the "Pins insertion" paragraph.
- From the "Flexion and extension gaps" to the "Pins insertion" paragraph.
- The "Femoral preparation guide placement", "Placement of trial femoral component", "Placement of trial tibial baseplate" paragraphs.

Not all devices presented in this Surgical Technique may be registered in your country. Please contact your Amplitude Sales Representative for availability.

## STARTING THE SOFTWARE



- Press the touch screen to select the preferred system language.
- Select « Knee », then select the implant and the 5-in-1 protocol.

- On the « Information » page, input the required information using the virtual keyboard.
  - Surgeon name
  - Patient name
  - Patient date of birth (optional)
  - Operated side (select right or left)
- To go to the next step, press the blue pedal or the blue arrow on the screen.
- To go to the previous step, press the yellow pedal or yellow arrow on the screen.

## SURGICAL PROTOCOL SELECTION



- Configuring the surgery-related options:

### **Three methods can be used to define the tibial rotation reference:**

- **Acquire two points on the tibial plateau** to define the frontal plane (default).
- **Acquire sagittal axis** by placing the probe tip along the sagittal axis (Akagi's line).
- **Acquire** sagittal plane by placing the probe tip along **the sagittal axis** (Akagi's line) **and then one additional point on medial side of tibial tuberosity** to define the sagittal plane.

### **Two navigation methods can be used for the tibial cut:**

- Using tibial navigation alignment device to navigate the pins of the tibial resection guide.
- Using universal alignment device to navigate the tibial resection guide.

### **The trial implants can be acquired either:**

- Femoral component first and then tibial baseplate.
- Tibial baseplate first and then femoral component.

- Press the blue pedal to go to the next step.

## SURGICAL PROTOCOL SELECTION

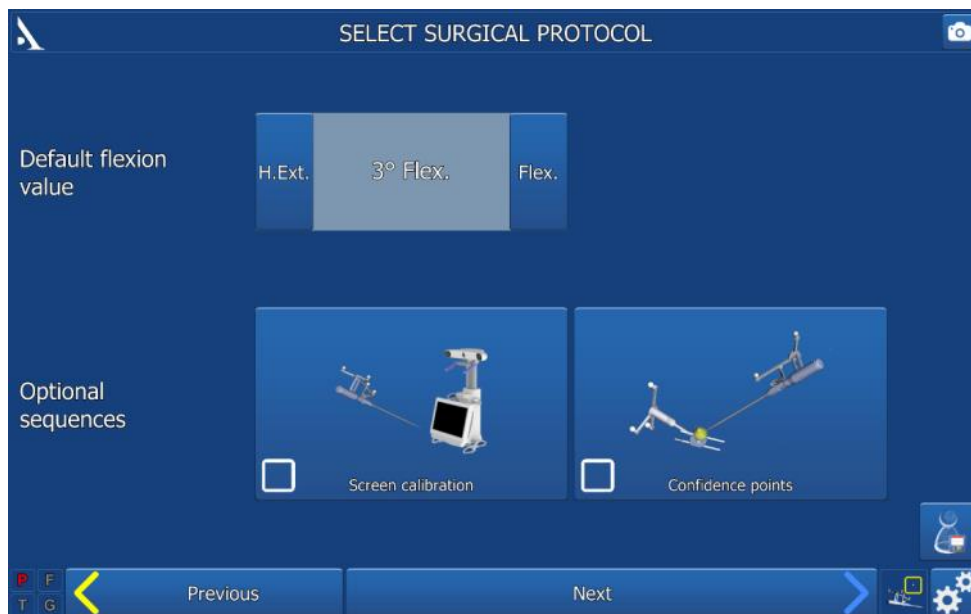

- Configuring the surgery-related options:

**Default flexion value:**

The default flexion deformity value is 3°; it can be modified by pressing "Hyperext." or "Flex".

**Optional sequences:**

- Calibrate Navigation Station Position.
- Tibia and Femur Reference Points.

- Press the blue pedal to go to the next step.

**NOTE**

During this step, a user profile can be created (see page 45) to save all the selected surgery-related parameters and automatically reuse them during the next surgical navigation with this implant

## PREPARATION PHASE



- Clip the AMPLIVISION sterile Markers (packaging per 14) to the arrays:
  - 3 for the T array, tibia navigation
  - 3 for the F array, femur navigation
  - 4 for the Probe, knee navigation
  - 3 for the G array, Instrumentation navigation

- The Conical Threaded Pins AMPLIVISION Ø4 length 150mm must be placed on the anteromedial side of the femur and tibia (when the surgeon stands on the lateral side) and must not interfere with tap placement. They can be inserted either percutaneously or through an incision.

### NOTE

If the femoral pin is being inserted percutaneously, make sure the knee is flexed to prevent damaging muscle fibres

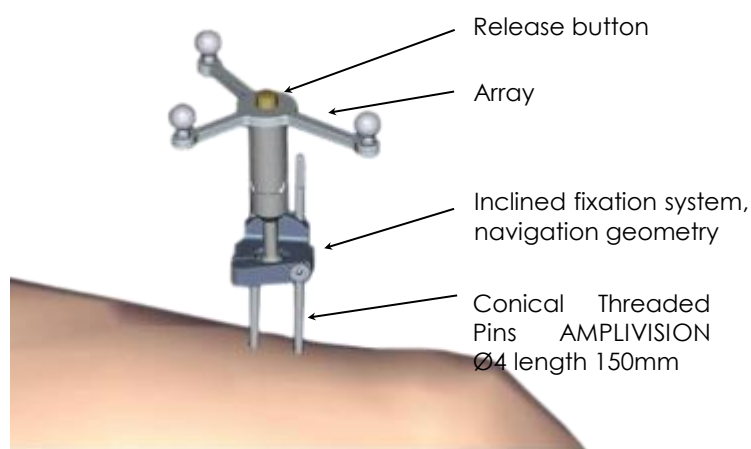

- Insert the first pin: go through the proximal cortex and then into, but not through, the distal cortex.
- Place the Inclined fixation system, navigation geometry, on the first pin to get the proper spacing for the second pin.

- Clip the F array on the moveable part of the support, making sure the arrows are aligned correctly. If the array needs to be removed during the procedure, it can be returned to the same position on the support.
- Orient the array towards the camera head and lock the fixation support.
- Position and secure the arrays so they are always visible to the camera head, whether the knee is flexed or extended.

F array, femur navigation

T array, tibia navigation

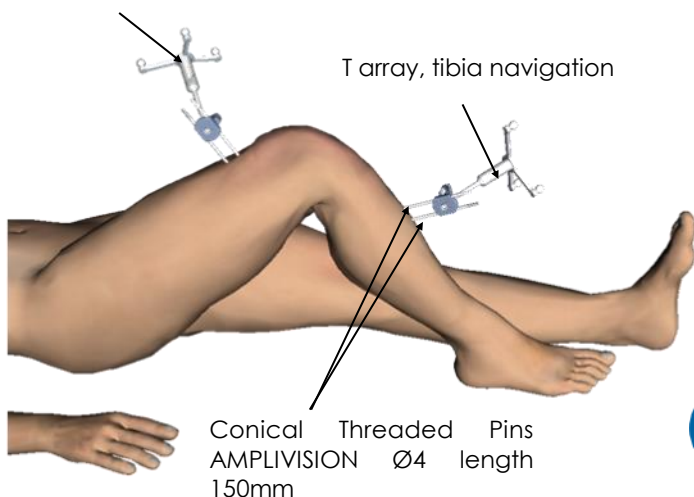

### NOTE

After approaching the joint and exposing the knee, it is important to remove the osteophytes in order to find the right joint surfaces to be palpated for the digitisation of the joint surfaces (otherwise there is a risk of over- or undersizing the size of the implant).



## WORKSTATION INSTALLATION

### SETTING UP THE CAMERA

- Position the camera head so the letters corresponding to the F and T arrays are in the middle of the field of view.

The laser located in the positioning handles on the camera head (V2 Workstation) or between the two optical sensors (V3 Workstation) makes this adjustment easier.

- Confirm that the Probe knee navigation P array is visible.
- On the left side of the screen, a 3D view of the arrays indicates why an array may not be visible:
  - Any marker that is not visible on an array will be red, as will the letter associated with this array.
  - The array will be green if it is fully visible.
- The array's visibility may be compromised by interfering infrared sources (sunlight, hot lights, dirty markers).



### NOTE

If screen calibration is not initially selected, the station position is set by default.

### CALIBRATING THE USER AND SCREEN

- Aim the probe at the centre of the AMPLIVISION® screen and press the trigger to confirm.
- From this step on, the AMPLIVISION® system can be controlled with:
  - the probe, by pressing the trigger to confirm,
  - the pedal,
  - the touchscreen of the AMPLIVISION® workstation.
- The system will capture screenshots when:
  - the user validates a step,
  - the user presses the screen capture button at the upper-right corner of the screen.

### Comments:

The user must make sure the arrays used in this step are fully visible.

The camera position may be recalibrated at any time:

- Press the "Options" button.
- Press the "Calibrate AMPLIVISION® workstation position" button.
- Validate the new position; the system will automatically return to the current surgical step.

## CALIBRATION OF THE PROBE AND ARRAYS

### CALIBRATING THE PROBE

To define exactly the position of the probe tip,

- Calibrate the probe by placing its tip in the conical calibration mark on one arm of the T array and press trigger to confirm.
- Without lifting the probe tip, change the probe's orientation slightly and then confirm again.

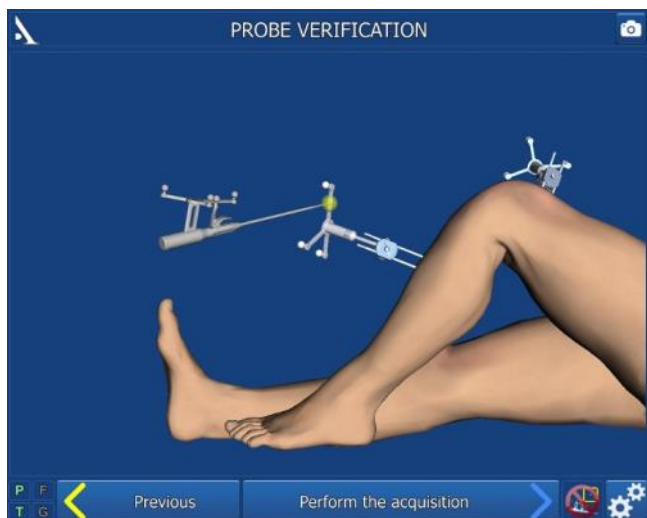

### TIBIA REFERENCE POINT ON ARRAY (OPTIONAL)

- This step validates the final position of the T array on its fixation support. At any point during the procedure, the surgeon can check if the array position has changed by using this reference point.
- Place the probe tip in one of the two conical calibration marks on the T array support and confirm.

#### NOTE

There is no way to check if the array–fixation support combination has moved. If in doubt, continue the procedure without navigation

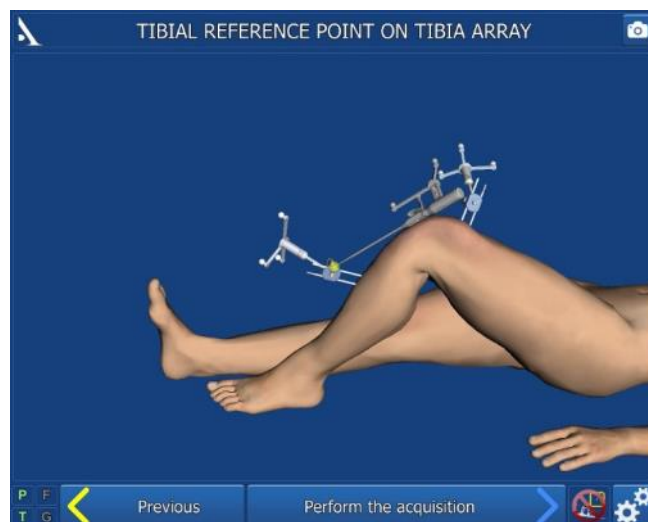

### FEMUR REFERENCE POINT ON ARRAY (OPTIONAL)

- Repeat these same steps with the F array support.
- At any time during the procedure, place the probe tip on the previously acquired tibia and/or femur reference point. The words « Femur OK » and/or « Tibia OK » will appear in the lower right corner of the screen if the array has not moved relative to its support.
- If the array has moved, the surgeon can continue the procedure without navigation or return to the reference point step.

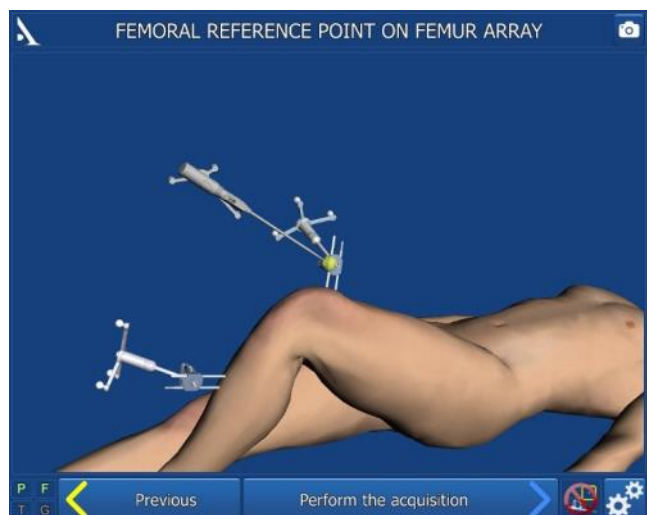

## TIBIAL AND FEMORAL REGISTRATIONS

### ANKLE CENTRE ACQUISITION

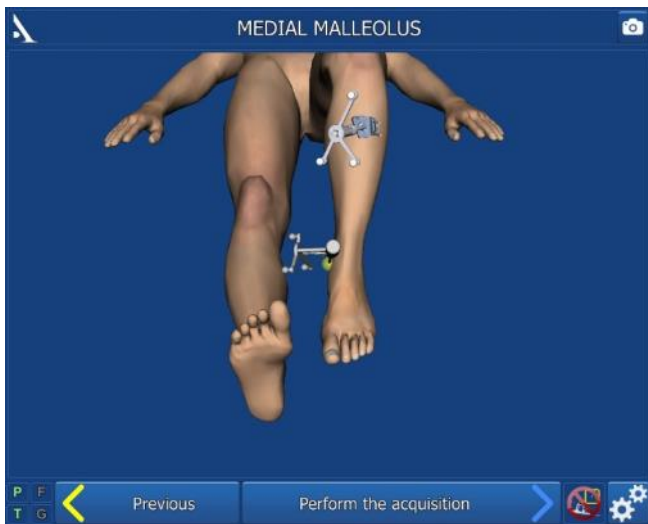

#### MEDIAL MALLEOLUS

- Place the probe tip on the most medial point of the medial malleolus.
- Press the trigger on the probe to confirm.

#### LATERAL MALLEOLUS

- Place the probe tip on the most lateral point of the lateral malleolus.
- Press the trigger to confirm.

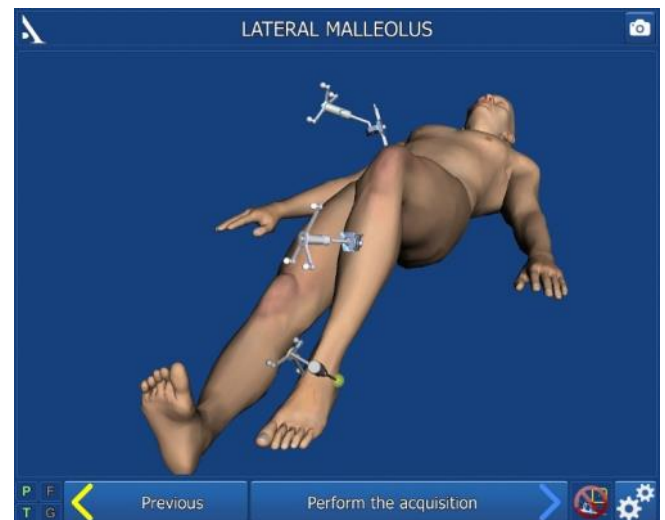

### HIP CENTRE ACQUISITION

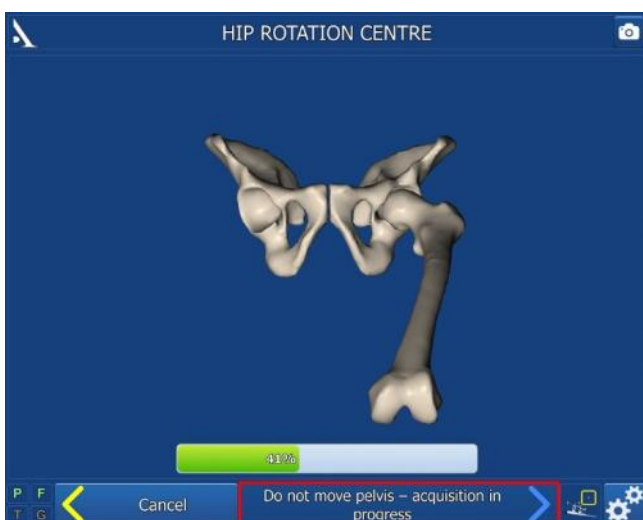

- Extend the patient's leg and grasp his/her ankle.
- Move the leg in a small circle (15 cm knee displacement), the acquisition will start automatically. Continue the movement until the system has acquired 100% of the points it needs.
- Once the acquisition is finished, the system will calculate the hip centre. If the result is acceptable, the system automatically goes to the next step. If it is not acceptable, the system will prompt the user to restart the acquisition. During this step, the system will beep once when the acquisition starts and once when it ends. A status bar shows the progress being made during the acquisition.

## TIBIAL AND FEMORAL REGISTRATIONS

### TIBIAL ACQUISITION



#### CENTRE OF TIBIA

- Place the probe tip on the middle of the intercondylar eminence on the axis of the tibial shaft.
- Press the trigger to confirm.

#### TIBIAL ROTATION REFERENCE

Acquisition of two points on the tibial plateau selected as rotational reference:



The frontal plane will run along the line formed by the two points acquired on the tibial plateaus. A line can be made on the tibial plateau with electrocautery to help with this acquisition.

- Place the probe tip on the middle of the medial plateau on the previously drawn line.
- Press the trigger to confirm.
- Place the probe tip on the middle of the lateral plateau on the previously drawn line.
- Press the trigger to confirm.

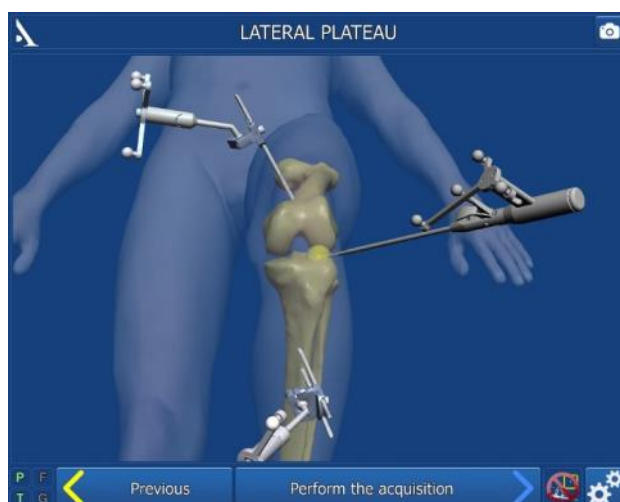

#### NOTE

The tibial axis is defined using the ankle centre (the point midway between the malleoli) and the point in the middle of the intercondylar eminence. Using the tibial axis and the frontal axis, the AMPLIVISION® system calculates the frontal plane and estimates the sagittal and transverse planes

## TIBIAL AND FEMORAL REGISTRATIONS

**Acquisition of tibial sagittal axis** selected as rotational reference:



- After the middle of the intercondylar eminence has been acquired, place the probe tip on the intercondylar eminence and turn the body of the probe.
- Once it corresponds to the desired sagittal plane orientation, confirm its position.

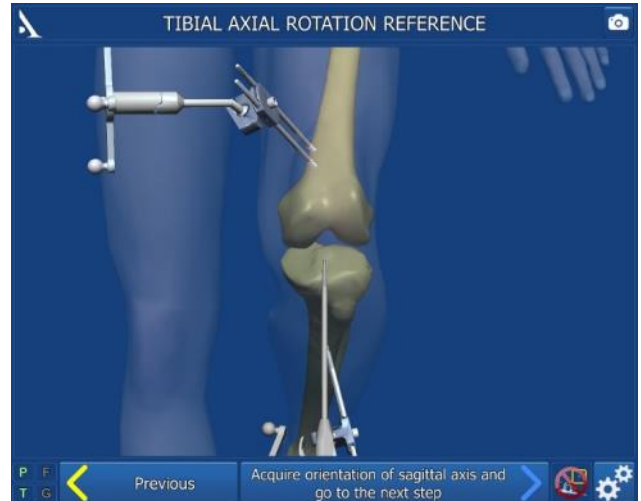

**Acquisition of tibial sagittal axis and a single point on medial aspect of tibial tuberosity** selected as rotational reference:



- After the middle of the intercondylar eminence has been acquired, place the probe tip on the intercondylar eminence and turn the body of the probe.
- Once it corresponds to the desired sagittal plane orientation, confirm its position.
- Acquire one point on the medial aspect of the tibial tuberosity.

### NOTE

The point acquired on the tibial tuberosity will be shown in green on the tibia views

### NOTE

The tibial axis is defined using the ankle centre (the point midway between malleoli) and the point in the middle of the intercondylar eminence. Using the tibial axis and the sagittal axis, the AMPLIVISION® system calculates the frontal plane and estimates the sagittal and transverse planes

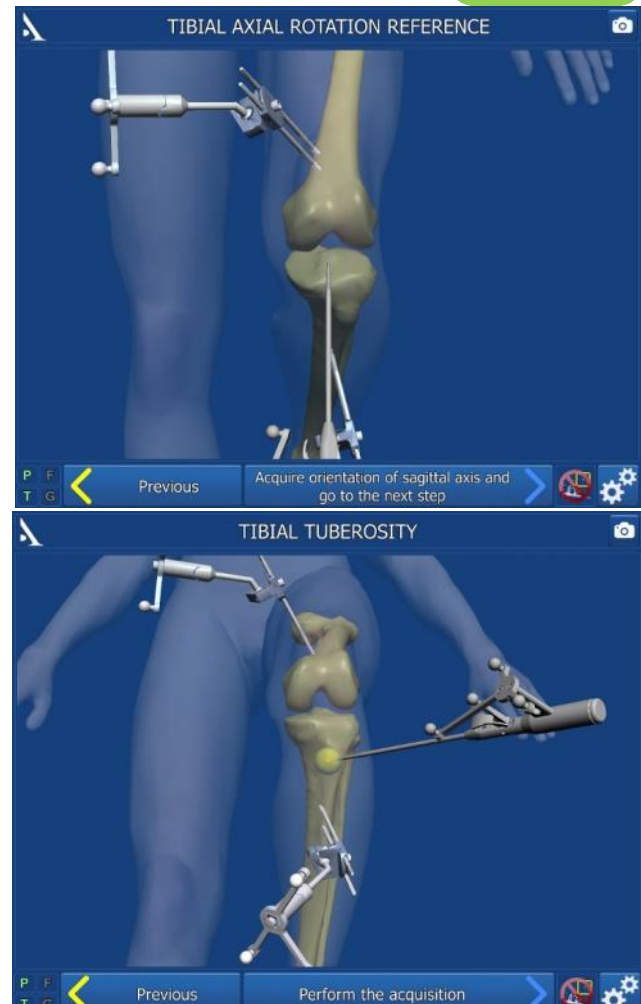

## TIBIAL AND FEMORAL REGISTRATIONS

### TIBIAL ACQUISITION



#### TIBIAL MORPHING

The goal of this step is to acquire the tibial bone surface and then verify its accuracy.

- The acquisition process is initiated by pressing the trigger on the probe and ends when the trigger is released. The system will beep to indicate the start and end of the acquisition.
- Place the probe tip on the bone surface. Hold down the trigger while moving the tip along the surfaces that need to be acquired:
  - Medial and lateral articular surfaces (used to determine height of cut)
  - Contour of tibial plateau at the articular surface (used to estimate implant size), as well as at the level of the planned tibial cut (anterior cortex, medial and/or lateral). This provides a good representation of the contact area between the chosen tibial baseplate and bone cut.



- At any time, the surgeon may release the trigger, move the probe tip to another location and then press the trigger again to continue the acquisition.
- The system will continuously acquire points and draw a contour map of the surface in real time. A counter in the upper-left corner shows how many points have been acquired.
- The software will not proceed to the next step until the anterior part and one of the two lateral parts are green.

#### NOTE

Make sure the probe tip is always in contact with the tibial bone surface when the trigger is pressed

#### VERIFICATION OF CONTOURS

- Release the trigger and place the probe tip on the acquired bone surface. The DISTANCE TO SURFACE value is shown: this distance is the error between the palpated point and the same point on the digitised 3D model (accuracy of contours). The number will be green if this distance is equal to or less than 1 mm, and red if it is not.

#### REMOVAL OF ACQUIRED POINTS

- The last 20 acquired points can be deleted by pressing the yellow pedal.
- Press and hold down the yellow pedal (for at least 2 seconds) to erase all the acquired points.
- If the contour accuracy is satisfactory, confirm this step and go to the next step.

## TIBIAL AND FEMORAL REGISTRATIONS

### FEMORAL ACQUISITION



#### TOP OF INTERCONDYLAR NOTCH

Place the probe tip at the top of the femur's intercondylar notch and along the femoral shaft axis, then confirm.

#### MEDIAL AND LATERAL POSTERIOR CONDYLES

Place the probe tip at the top of the medial posterior condyle and confirm; do the same for the top of the lateral posterior condyle.

#### NOTE

The femur's mechanical axis is calculated using the hip centre and top of the intercondylar notch. Using the femur's mechanical axis and the posterior condylar axis, the AMPLIVISION® system calculates the frontal femoral plane and estimates the sagittal and transverse planes

#### NOTE

The points at the top of the posterior condyles are recalculated during the condyle digitisation. The planes are then recalculated to make them more accurate

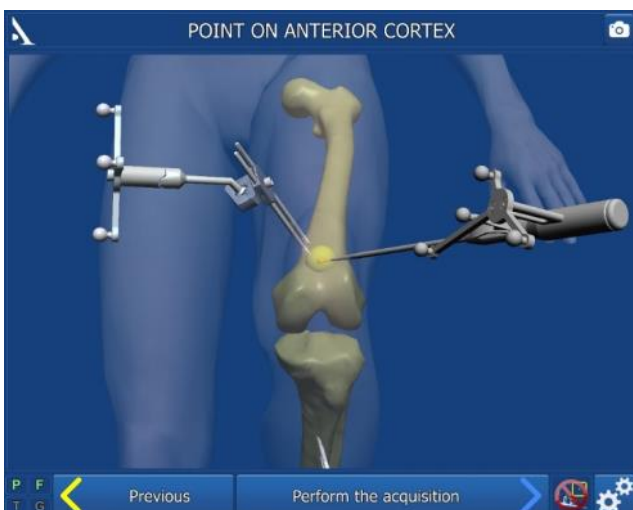
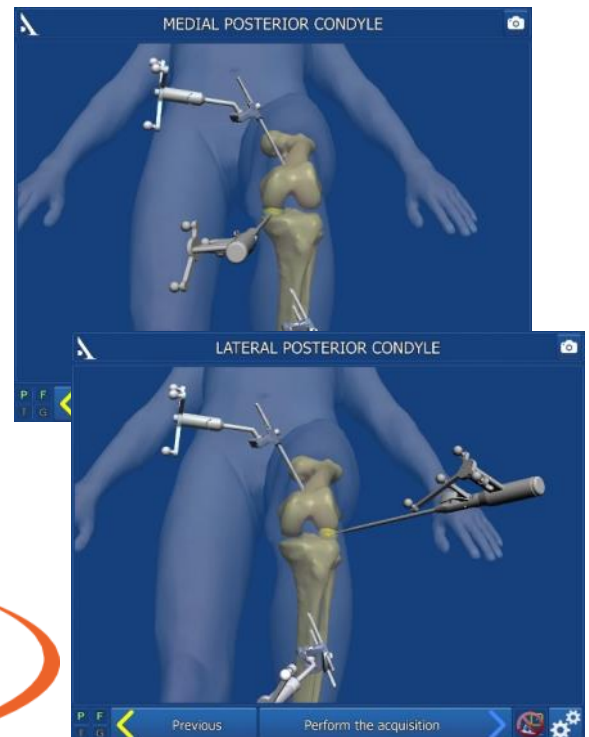

#### ANTERIOR CORTEX

Place the probe tip on the anterior femoral cortex and confirm.

## TIBIAL AND FEMORAL REGISTRATIONS

### FEMORAL ACQUISITION

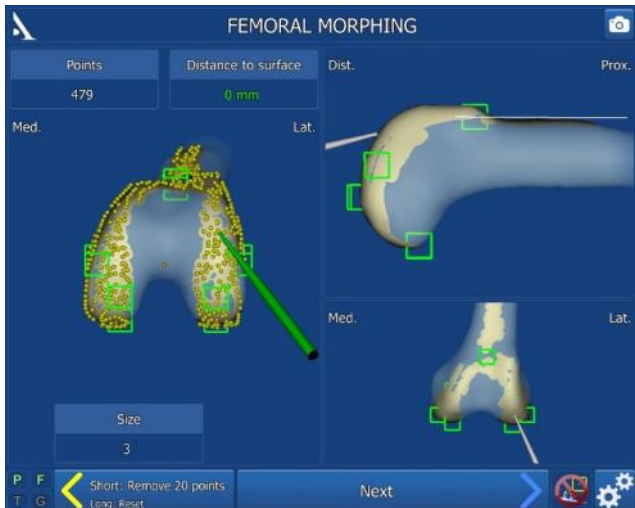
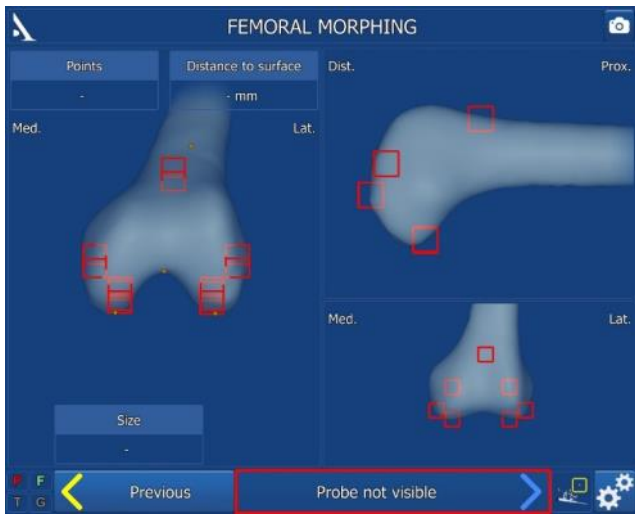

### FEMORAL MORPHING

The goals of this step are to acquire the femoral bone surface and verify its accuracy

- Place the probe tip on the bone surface. Press and hold trigger then move the tip along the surface being acquired.
- It is best to draw the contour of the femur carefully.
- At any time, the surgeon may release the trigger, move the probe tip to another location and then press the trigger again to continue the acquisition.
- The acquisition process is initiated by pressing the trigger on the probe and ends when the trigger is released. The system will beep to indicate the start and end of the acquisition.
- A counter in the upper-left corner shows how many points have been acquired.
- Once the minimum number of points needed for the seven «regions of interest» (anterior, distal medial, distal lateral, posterior medial, posterior lateral, medial epicondyle, lateral epicondyle) have been acquired, the red cubes will become green.
- The system will continuously acquire points and draw a contour map of the surface in real time and the matching femoral component size is shown in the lower left part of the screen.

#### NOTE

Make sure the probe tip is always in contact with the femoral bone surface when the trigger is pressed

#### NOTE

When enough points have been acquired on the anterior cortex, the line on the anterior cortex appears in white



## TIBIAL AND FEMORAL REGISTRATIONS

### VERIFICATION OF CONTOURS

- Release the trigger and place the probe tip on the acquired bone surface. The DISTANCE TO SURFACE value is shown: this distance is the error between the palpated point and the same point on the digitised 3D model (accuracy of contours). The number will be green if this distance is equal to or less than 1 mm and red if not.

### REMOVAL OF ACQUIRED POINTS

- The last 20 acquired points can be deleted by pressing the yellow pedal.
- Press and hold down the yellow pedal (for at least 2 seconds) to erase all the acquired points.
- If the contour accuracy is satisfactory, confirm this step and go to the next step.

If the sagittal **axis plus one point on the medial side of the tibial tuberosity** was chosen as the rotation reference:

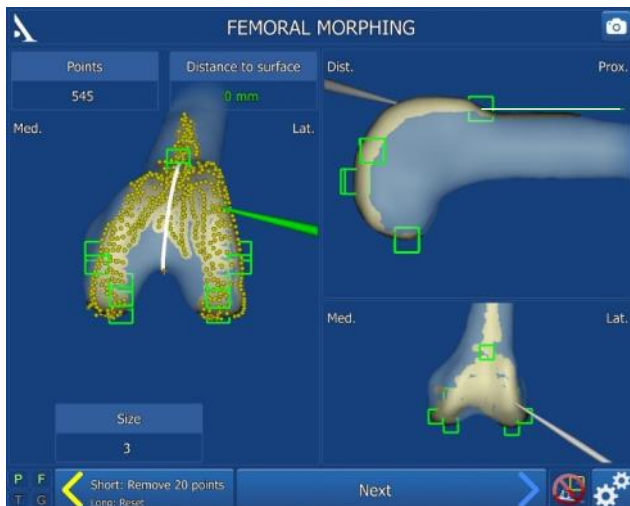

A white line corresponding to the anatomical Whiteside's line is displayed when points are acquired at the base of the trochlea.

## TIBIAL AND FEMORAL REGISTRATIONS

### PRE-OPERATIVE HKA RECORDING

- Extend the leg so that there is no load on it.
- View the pre-operative HKA angle.
- Validate with the knee extended. This pre-operative HKA angle will be recorded in the postoperative report.

#### NOTE

With the leg extended, a varus or valgus load can be placed on the leg to determine whether the pre-operative deformity can be reduced. This should be performed before moving to the next step

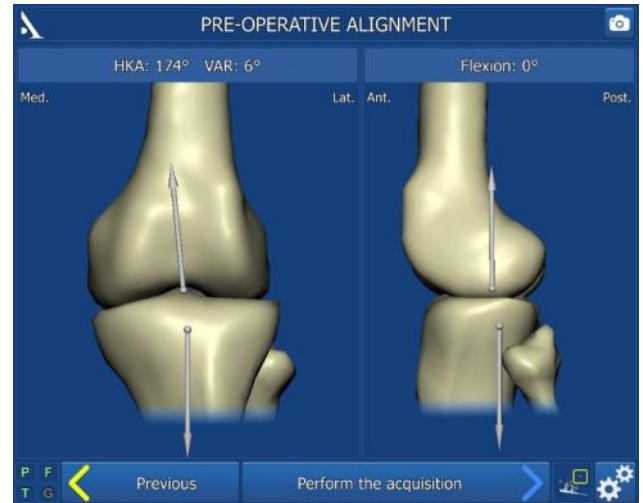

## TIBIAL PLANNING

### MOST WORN AREA

- Use the information from the heat map showing the healthiest areas (highest points) in green tints and the most worn areas (lowest points) in red tints to select the most worn point on the two tibial plateaus and acquire it.

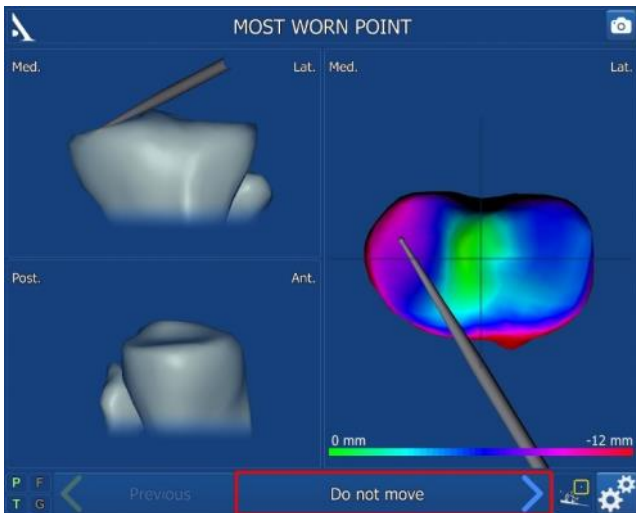

### REFERENCE POINT FOR TIBIAL RESECTION HEIGHT

- Select the reference point that will be used to define the resection height, e.g. a point on the healthy side.
- The preset bone resection thickness is shown between this point and the red line (cut level); the default is 10 mm.
- On the side of the worn plateau, the distance between the previously acquired most worn point and the planned resection level is shown in orange; this ensures the cut is made below the most worn point.
- If needed, the resection height shown in the upper right corner of the screen can be adjusted using the +/- keys on the touch screen.
- If the reference point for the tibial resection height is no longer suitable, acquire a new point on the articular surface by pressing the trigger.
- If the tibial slope needs to be measured, hold the probe against the anterior and posterior edge of the tibial plateau. The posterior tibial slope will be displayed on the screen (calculated from the probe axis and the tibia's transverse plane). The desired tibial slope can be adjusted using the +/- keys on the touch screen.
- Press the trigger on the probe to start acquiring the reference point and to go to the next step.

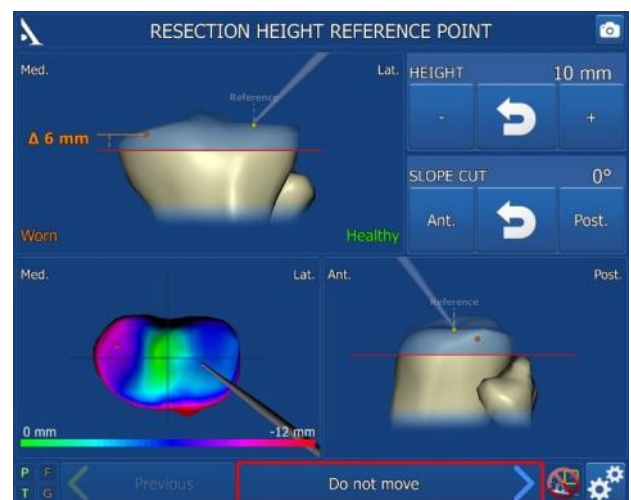
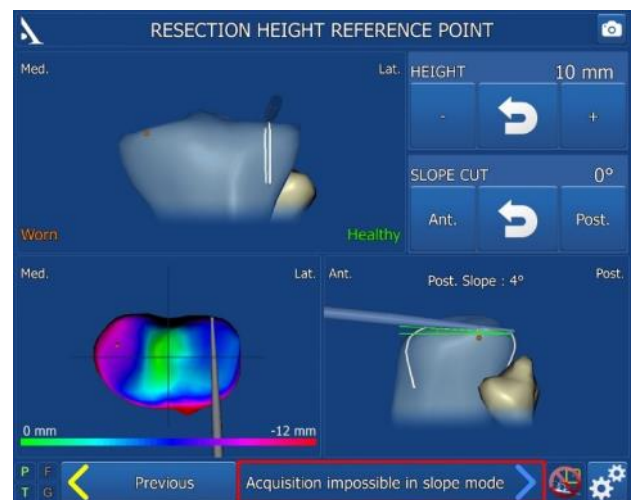

## TIBIAL PLANNING

### TIBIAL PLANNING

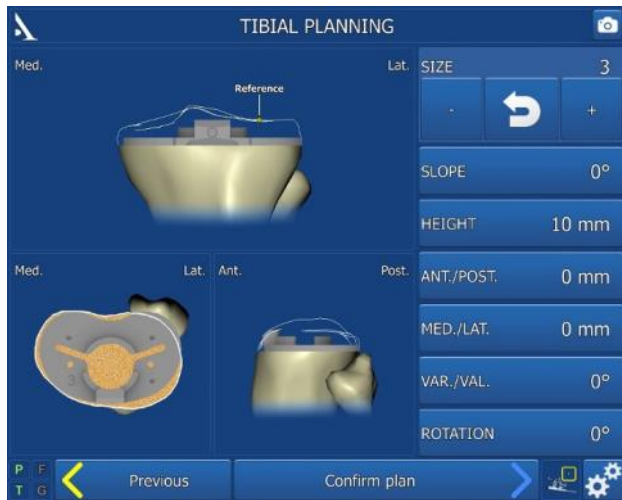

- Before making the fibial cut, a suggested tibial baseplate size and position are given.
- All the potential adjustments to the position of the tibial baseplate are shown on the right side of the screen.
- Use the +/- keys on the touchscreen to adjust the size and position of the implant, as needed.
- Press the red arrow button in the middle to return to the default value.
- Validate the plan once the desired changes (if any) have been made.

## TIBIAL NAVIGATION

### TIBIAL ALIGNMENT GUIDE CALIBRATION



- Flex the knee.
- Assemble the Tap for navigation into the power tool and drive it into the tibia along the shaft axis, but leave a few threads showing. Manually finish screwing in the tap with the universal T-handle.
- Secure the G array to the Alignment guide for tibial navigation. Place the guide on the Navigated Tibial Arm. Secure the components together by tightening the side screw.
- Place the Navigated Tibial Arm over the tap and preset the rotation by putting the bracket in the sagittal axis (0° rotation). Lock the rotation by turning the side screw on the bracket.
- Calibrate the Alignment guide for tibial navigation by placing the probe tip in one of the three conical marks on the guide and confirm its position by pressing on the blue pedal or the trigger. Repeat with the two other marks. The mark will turn green on the screen once it has been acquired.
- Calibration marks can be acquired in any order.

#### NOTE

Refer to page 48 for Alignment guide for tibial navigation assembly

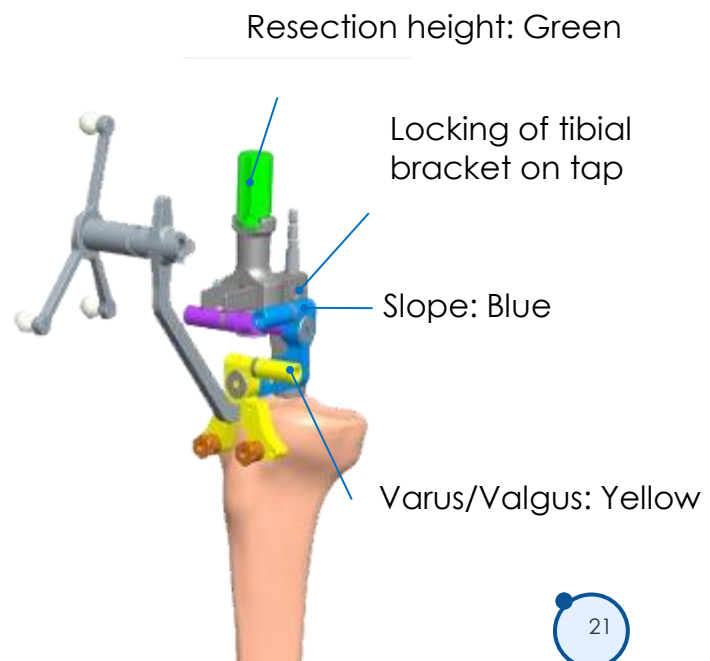
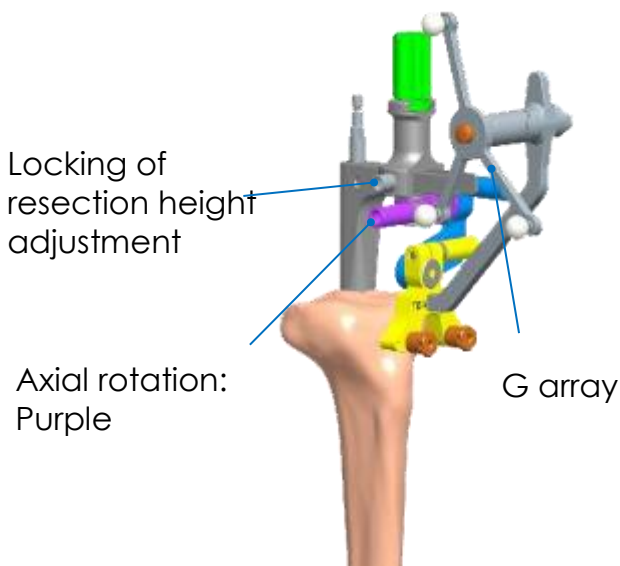

## TIBIAL NAVIGATION

### NAVIGATION OF TIBIAL CUT



- The three previously confirmed parameters for the position of the tibial resection plane are shown on the screen. Each of these parameters is shown on a different colour background. These colours match the colours on the component of the tibial alignment guide used to adjust that particular parameter.
- Two values are shown for each parameter:
  - The planned value is in blue; this is the target value.
  - The navigated value remains in red as long as the guide is not in the correct position. It will turn green when the value is within  $\pm 1$  mm or  $\pm 1^\circ$  of the planned value.
- Adjust the parameters one at a time. For example, to set the slope (blue), loosen the blue binding screw using the H5 screwdriver, adjust the guide's position until the navigated value turns green, and then retighten the screw.
- The height of the cut (green thumb knob) should be the last parameter adjusted.
- Once the guide is correctly positioned, the value and resection plane are shown in green. Once the navigated values have been adjusted and have stabilised, the words « Insert pins, confirm and cut » will appear.
- Insert the Headless pins length 80 mm into the two Guiding Sleeve - Tibial Navigation while making sure the values are unchanged. Use the Universal quick release adaptor for pin or Pin Driver AO) to drive the pins into the bone.
- After inserting the pins and checking that the tibial alignment guide has not moved, confirm the position (blue pedal, probe or touchscreen).
- Carefully remove the two Guiding Sleeve - Tibial Navigation. Loosen the height adjustment screw and slide the alignment guide off the tibial bracket. Loosen the screw for the tibial bracket on the tap, remove the tibial bracket, and then remove the tap using the universal T-handle.
- Place the Tibial resection guide (or the 4T Tibial Resection Guide - 0°) on the Headless pins (0 holes).
- Perform the tibial cut (described in the Conventional Surgical Techniques 5-in-1 TO.G.GB.021 for SCORE® and SCORE® II Knees, TO.G.GB.023 for SCORE® II (4T instrumentation set), TO.G.GB.029 for Revision SCORE® Knee and TO.G.GB.014 for ANATOMIC® Knee).

## TIBIAL NAVIGATION

### ACQUISITION OF TIBIAL RESECTION PLANE



- Place the G array on the Measuring Plate for Tibial Resection –Navigation.
- Position the plate on the tibial cut and confirm its position.

#### NOTE

If the tibial slope is not as steep as desired (due to saw blade buckling), it can be adjusted with the flat rasp

## FEMORAL PLANNING

### HKA ANGLE AND LIGAMENT GAP BALANCING SIMULATION

IN EXTENSION



- Assemble the universal handle with the adjustable Spacer navigation. Place a 2 mm Full wedge height 2 mm under the spacer to reproduce the tibial component's minimum size (8 mm spacer + 2 mm wedge = 10 mm). A Full wedge height 4 mm is also available if needed.
- With the knee extended, place the adjustable Spacer navigation between the tibial cut and femur. The adjustable spacer has two moving bearings that are adjusted using the micrometric screw. These two bearings must be placed against the femoral condyle. On the screen, you can view the resulting gaps after a virtual femoral component (software determined) is implanted.

- The HKA angle shown on the screen is the one observed on the patient. To view the resulting gaps and ligament tension for a desired HKA angle, the spacer bearings can be adjusted to fill in the patient's worn areas on the femur.
- Use the H5 screwdriver to open the bearing on the most worn side until the desired HKA angle is achieved. If the bearing's maximum displacement (2 mm) is not enough, Half-wedge 2, 4 and 6 mm can be added.
- Once the desired HKA angle is obtained, the ligament gap balance can be evaluated and adjusted by releasing ligaments and/or changing the position of the virtual femoral component. The values shown on the right side of the screen can be altered by pressing the keys on the touchscreen or by using the probe.

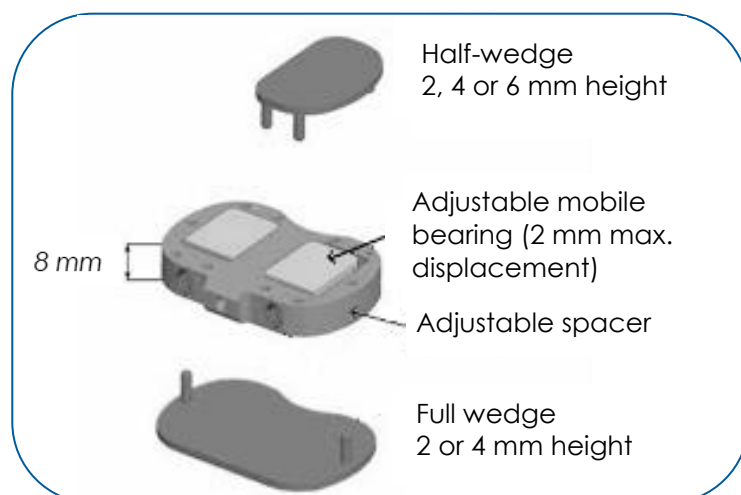

#### NOTE

The displayed values correspond to the actual tibial cut made and the **virtual** femoral component positioned by the software



## FEMORAL PLANNING

### HKA ANGLE AND LIGAMENT GAP BALANCING SIMULATION

IN FLEXION



- Once the extension balancing has been completed, bend the knee to 90°.
- Use the Spacer navigation to equal the insert height suggested during the previous step (value shown on screen between tibial cut and virtual femoral component while in extension), to verify the flexion gap and ligament balance.

#### NOTE

When the knee is flexed, place the bearings in the lower portion of the Spacer navigation

- The values on the screen can be adjusted to simulate external rotation of the virtual femoral component so as to refine the gap balance. The displayed values correspond to the tibial cut that has been made and the virtual femoral component, which is in a position determined by the software.

### FLEXUM/HYPEREXTENSION POSITIONING

- Press the « Flex./Hyperext. » button. A side view of the femur is displayed in the lower part of the screen.
- The angle between the anterior cortex and the normal to the distal plane of the planned implant is displayed (this angle only appears if during femoral scanning, enough points have been acquired anteriorly and the line on the anterior cortex has been displayed in white).



## FEMORAL PLANNING

MAKING A DISTAL FEMORAL CUT GREATER THAN 8 MM



- The contact area between the femoral component and the distal cut is outlined in black on the condyles.
- The thickness of the cut on each condyle is shown.
- Increase the thickness of the distal femur cut using the touch screen (2 mm increments) in cases where:
  - the distal cut on either of the condyles is non-existent or insufficient (genu valgum),
  - there is significant preoperative genu flexum,
  - the joint line must be shifted upwards.
- A distal precut step will be added once the distal femoral Smooth pins Ø4, length 90 mm have been inserted.

## FEMORAL PLANNING

### MEDIOLATERAL POSITIONING

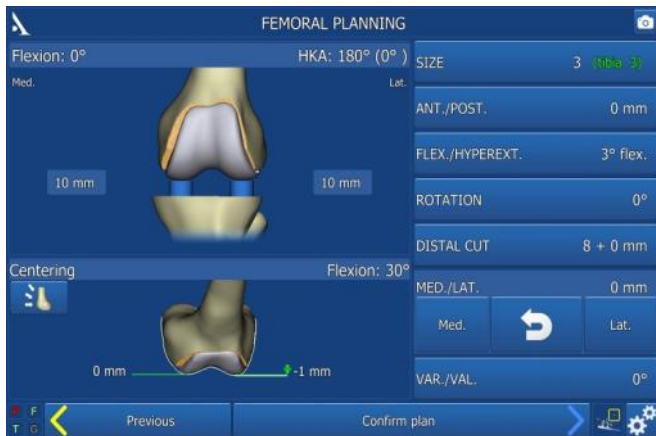

- The position of the femoral component under the patella can be determined with the software.
- Press the « Med./Lat. » button. An image of the femoral component will appear on the lower part of the screen.
- Adjust the mediolateral position of the femoral component according to the native and replacement trochlea shown in white.
- If the implant is above or below the native femur, the difference is shown (indication for adjusting the tension of the patellar fins).
- This information is provided for 30°, 60° and 80° of knee flexion. Press the button  to switch between the three views.

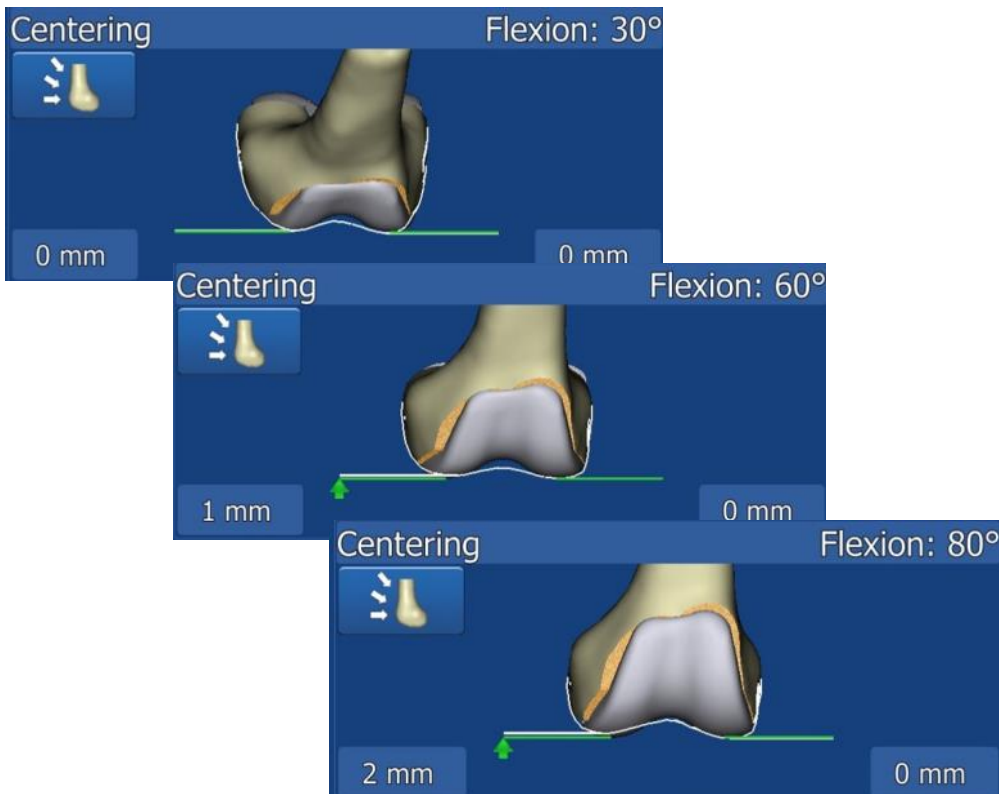

## FEMORAL PLANNING

### HKA ANGLE AND LIGAMENT GAP BALANCING

If the **sagittal axis plus one point on the medial side of the tibiale tuberosity** was chosen as the rotation reference:

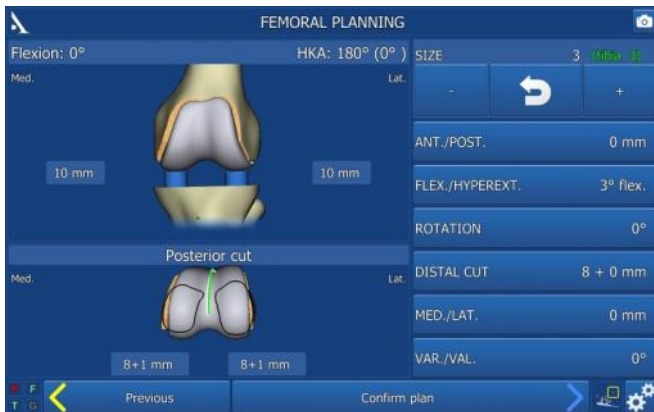

- The **anatomical** Whiteside's line is displayed in **white**, along with the trochlea's axial rotation.
- The **implant's** Whiteside's line is shown in **green**.



## FEMORAL NAVIGATION

### FEMORAL ALIGNMENT GUIDE CALIBRATION

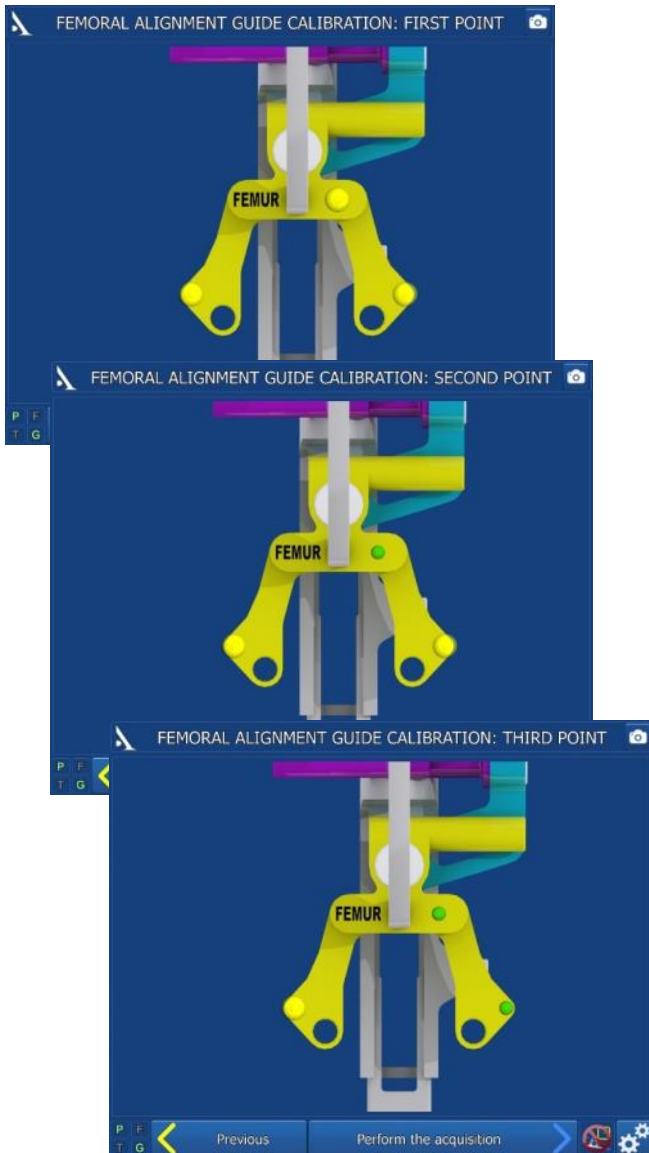

- Bend the knee to 90°.
- Assemble the tap onto the power tool and drive it into the femur along the shaft axis, but leave a few threads showing. Manually finish screwing in the tap with the universal T-handle.
- Secure the G array to the Alignment guide for femoral navigation.
- Assemble the femoral alignment guide and the Removable valgus guide - Femoral navigation on the tap. Place the valgus barrel (make sure the correct side is chosen and the label is visible to the surgeon) and ensure the posterior forks touch the posterior condyles.
- Calibrate the femoral alignment guide by placing the probe tip in one of the three conical marks on the guide and confirm its position by pressing on the blue pedal or the trigger. Repeat with the two other marks. The mark will turn green on the screen once it has been acquired.
- Calibration marks can be acquired in any order.

#### NOTE

Refer to page 49 for Alignment guide for femoral navigation assembly

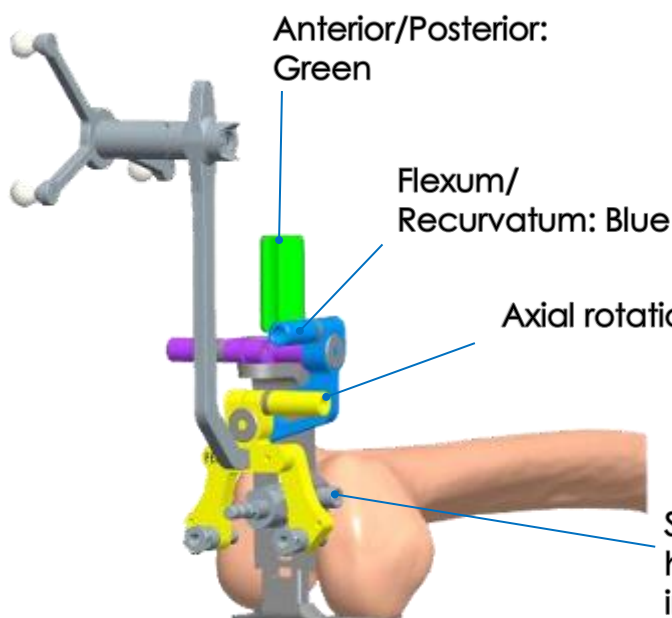

Screw to lock position of resection height and posterior fork height on the intramedullary rod or tap

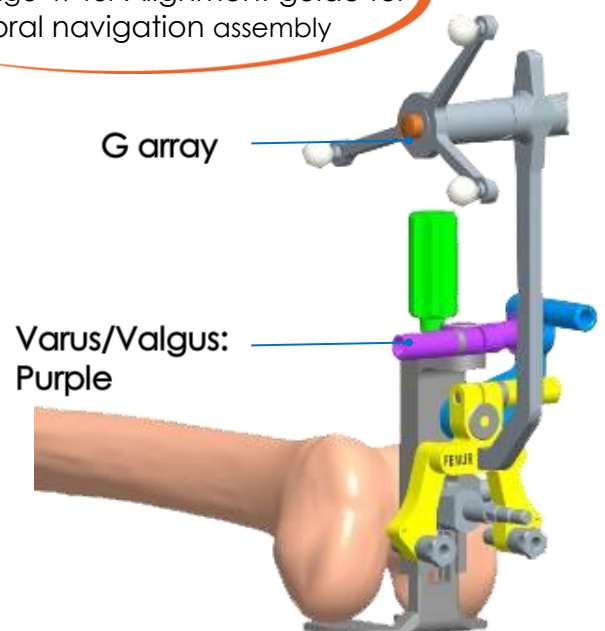

## FEMORAL NAVIGATION

### NAVIGATION OF FEMORAL CUTS

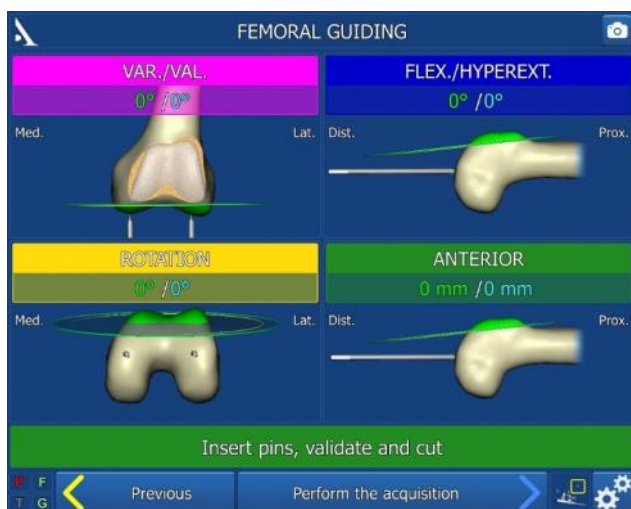

- The four parameters on the screen can be adjusted before placing the femoral pins so that the femoral cuts can be carried out as planned in the previous steps. Each of these parameters is shown on a different colour background. These colours match the colours on the component of the tibial alignment guide used to adjust that particular parameter.
- Two values are shown for each parameter:
  - The planned (target) value to be achieved is in blue,
  - The navigated value remains red as long as the guide is not in the correct position. It will turn green when the value is within  $\pm 1$  mm or  $\pm 1^\circ$  of the planned value.

- Adjust the parameters one at a time. For example, to set the flexum/recurvatum, loosen the blue binding screw using the H5 screwdriver, adjust the guide's position until the navigated value turns green, and then retighten the screw.
- The anteroposterior position (green thumb knob) should be the last parameter to be adjusted.
- Once the guide is correctly positioned, the value and resection plane will be shown in green.
- Evaluate the size of the anterior cut relative to the anterior cortex on this view. Once the navigated values have been adjusted and have stabilised, the words « Insert pins, confirm and cut » will appear.
- Insert the Smooth pins  $\varnothing 4$ , length 90 mm into the two Drill guides for pin  $\varnothing 4$  while making sure the values are unchanged.
- After inserting the pins and checking that the femoral alignment guide has not moved, confirm the position (blue pedal, probe or touchscreen).
- Carefully remove the two drill guides. Loosen the screw used to lock the resection height adjustment and slide the alignment guide off the tap. Remove the tap using the universal handle.
- Place the Femoral resection guide (or the IMA Femoral Resection Guide) corresponding to the planned size (and shown on the screen) on the two femoral pins.
- Perform the femoral cuts (described in the Conventional Surgical Techniques 5-in-1 TO.G.GB.021 for SCORE® and SCORE® II Knees, TO.G.GB.029 for Revision SCORE® Knee and TO.G.GB.014 for ANATOMIC® Knee).

#### NOTE

Refer to next page if the planned distal femoral cut is greater than 8 mm

## FEMORAL NAVIGATION

### IF A DISTAL FEMORAL PRECUT IS NEEDED



Planning for 8+2 mm distal cut

- After the pins have been inserted (but before making the five femoral cuts), the Distal femoral reamer (as shown on the screen) will be used to perform the planned precut.
- Position the reamer on the femoral pin on the appropriate side and slide it up against the condyle.
- Set the stop to the resection value shown on the screen (2 mm increments).
- Assemble the reamer on the power tool and make the distal precut.
- Next, place the femoral resection guide corresponding to the planned size (and shown on the screen) on the two femoral pins and continue with the protocol shown on previous page.



## FEMORAL NAVIGATION

### FEMORAL PREPARATION GUIDE PLACEMENT

This step only applies to the ANATOMIC® and Revision SCORE® implants.

#### NOTE

This step is optional. If centring the guide without navigation assistance, skip this step by pressing the blue pedal, probe or blue arrow

#### For ANATOMIC® Knee:

- Choose the same size of Femoral preparation guide as the 5-in-1 resection guide used previously (the planned size is shown on the screen).
- Place the universal handle on the oval clip by simultaneously pushing and turning the handle one-quarter turn.
- Place the probe tip on the conical mark located on the front of the femoral preparation guide. The mediolateral distance between the planned position (blue value) and true guide position will be shown (yellow value).

Once the guide has been centred in the mediolateral direction, remove the universal handle and secure it with three Headed pins length 30 mm.

- Prepare the femoral trochlea (described in the Conventional Surgical Technique 5-in-1 TO.G.GB.014 for ANATOMIC® Knee).

#### For Revision SCORE® Knee:

Choose the same size of Femoral trochlear groove preparation guide as the 5-in-1 resection guide used previously (the planned size is shown on the screen).

- Place the probe tip on the conical mark located on the front of the trochlear groove preparation guide. The mediolateral distance between the planned position (blue value) and true guide position will be shown (yellow value).
- Once the guide has been centred in the mediolateral direction, remove the universal handle and secure it with 2 Headed pins length 30 mm.
- Prepare the trochlear groove (described in the Conventional Surgical Technique 5-in-1 TO.G.GB.029 for Revision SCORE® Knee).





## TRIALS

### PLACEMENT OF TRIAL FEMORAL COMPONENT

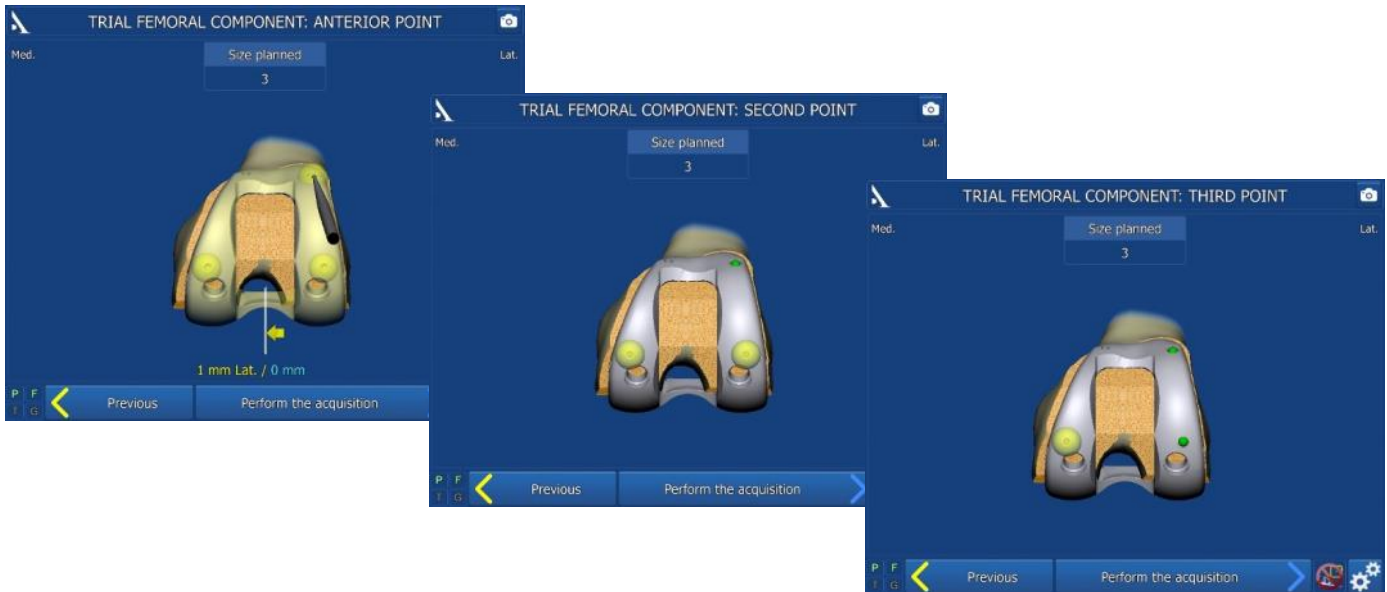

- Select the trial femoral component of the same size as the 5-in-1 resection guide used in the previous steps (the planned size is shown on the screen) and of the same operated side.
- For the Revision SCORE® Knee, assembly of the trial femoral component is described in the Conventional Surgical Technique 5-in-1 TO.G.GB.029).
- For the SCORE® and SCORE® II Knees: place the probe tip on the conical mark located on the front of the trial femoral component. The mediolateral distance between the planned position (blue value) and true guide position will be shown (yellow value).
- Finish impacting the trial component using the femoral component impactor.
- For the SCORE®, SCORE® II and ANATOMIC® implants (if it was not done with the femoral preparation guide): mark the entry point for the two pegs with the drill bit with stop while making sure the bit is well aligned with the pegs. Insert the 2 trial pegs.

### FEMORAL SUMMARY



- The trial implant's position (grey) is superimposed over the planned implant position (blue).
- The size and final position of the trial femoral component are shown in white; the planned values are in blue.

## TRIALS

### PLACEMENT OF TRIAL BASEPLATE

For ANATOMIC® Knee: see next page

For SCORE®, SCORE® II and Revision SCORE® Knees: 2 possibilities



Detection of G array  
by camera



#### NOTE

If the planned position does not exactly match the correct bone position, its position can be confirmed even if some of the baseplate position values are still red

#### Acquisition of trial baseplate position using conical calibration marks:

- Select the appropriate tibial baseplate (the planned size is shown on the screen) and secure it to the universal handle.
- Position and secure the trial baseplate with two, 30-mm long headed pins.
- Using the probe, acquire the position of the three calibration marks located on the baseplate to identify its position on the tibia.

#### Navigation of trial baseplate position with universal handle:

- Secure the G array support to the universal handle.
- Select the appropriate tibial baseplate (the planned size is shown on the screen) and secure it to the universal handle.
- Place the trial tibial baseplate on the tibial cut and compare its medio-lateral, anteroposterior and rotational position values with the planned values. The values will be displayed in red if they are beyond  $\pm 2$  mm or  $\pm 2^\circ$  from the planned values (in blue), otherwise they will be green.
- Use the arrows to adjust the baseplate position to match the planned position.
- Once the trial baseplate's position has been determined, secure the trial baseplate with two Headed pins length 30 mm.
- Confirm its position by pressing the blue pedal.

## TRIALS

### TRIAL BASEPLATE PLACEMENT

For the ANATOMIC® implant: 2 options



Detection of G array by camera

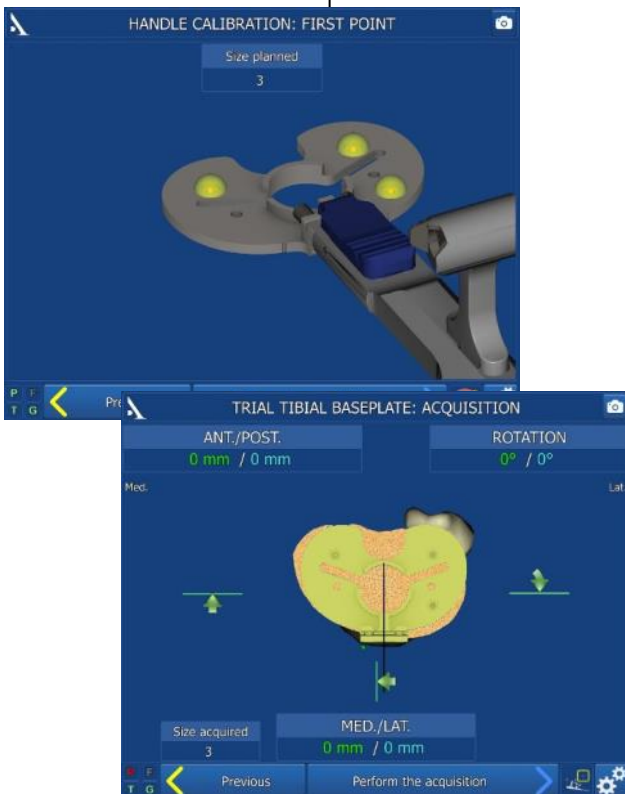

#### NOTE

If the planned position does not exactly match the correct bone position, its position can be confirmed even if some of the baseplate position values are still red

#### Acquisition of trial baseplate position using conical calibration marks:

- Select the appropriate tibial baseplate (the planned size is shown on the screen) and secure it to the baseplate handle.
- Position and secure the trial baseplate with two Headed pins length 30 mm.
- Using the probe, acquire the position of the three calibration marks located on the baseplate to identify its position on the tibia.

#### Navigation of trial baseplate position with baseplate handle:

- Secure the array support to the baseplate handle, and then attach the G array.
- Select the appropriate tibial baseplate (the planned size is shown on the screen) and secure it to the baseplate handle.
- Calibrate the handle's position by placing the probe on each of the three calibration marks on the baseplate.
- Place the trial tibial baseplate on the tibial cut and compare its mediolateral, anteroposterior and rotational position values with the planned values. The values will be displayed in red if they are more than  $\pm 2$  mm or  $\pm 2^\circ$  from the planned values (in blue), otherwise they will be green.
- Use the arrows to adjust the baseplate position to match the planned position.
- Once the trial baseplate's position has been determined, secure the trial baseplate with two Headed pins length 30 mm.
- Confirm its position by pressing the blue pedal.

## TRIALS

### TIBIAL SUMMARY



- The trial implant's position (grey) is superimposed over the planned implant position (blue).
- The size and final position of the implant are shown in white; the planned values are in blue.

## TRIALS

### IN EXTENSION



- Install a trial insert of the same thickness as the gaps shown during ligament balancing.
- Extend the leg.
- The HKA angle, and medial and lateral gaps with the trial components in place will be displayed.

### IN FLEXION

- Flex the knee.
- The flexion gaps with the trial components will be displayed.
- During these steps, pressing the blue pedal (or blue arrow) saves the information on the screen (regardless of flexion angle).
- All navigation steps have been completed.



For the tibial preparation, patellar preparation and implant insertion steps, refer to the following Surgical Technique documents: TO.G.GB.021 for SCORE®, TO.G.GB.045 for SCORE® II, TO.G.GB.029 for Revision SCORE® and TO.G.GB.014 for ANATOMIC®.

## SAVING THE SURGERY REPORT

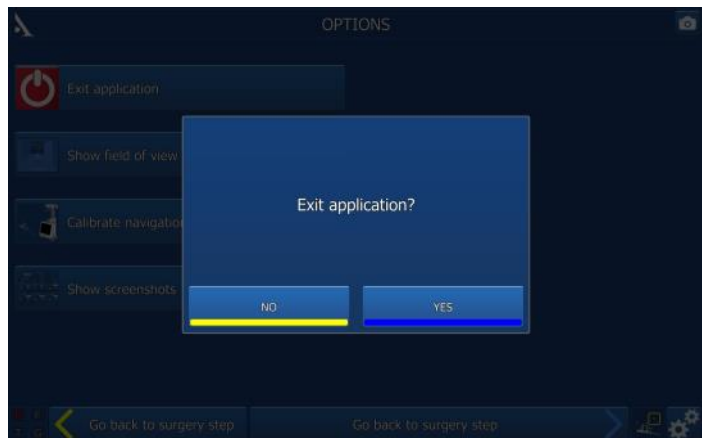

- Press the  button to exit the application:
  - It is available immediately after the last step of the « Post-operative alignment » procedure or
  - it can be found on the « Options » page at any point during the procedure.
- The message « Do you really want to exit? » will appear. Press « Yes » to confirm.
- The message « Copy report to USB drive? » will appear.
- Indicate whether you want to create a backup copy of the surgery report by pressing the « Yes » or « No » button.

- A message will appear asking you to insert a USB drive. Insert the USB drive in the slot close to the screen and confirm that you would like to backup the report.
- In the surgery report, a file named « report.html » contains the following elements:
  - Patient name and surgeon name
  - Bone contour maps
  - Bone resection planning pages
  - Implant size and position planning pages
  - Postoperative validation pages.

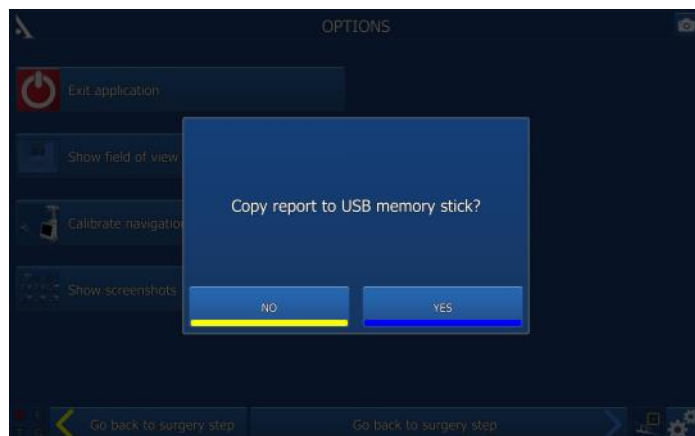

## POWERING DOWN THE WORKSTATION

- Press the  button at the the lower right corner of the screen.
- Confirm that you want to shut down the system.
- The system will shut down.
- Refer to the AMPLIVISION® NO114 (AMPLIVISION® V2) and NO205 (AMPLIVISION® V3) User Manual for instructions on how to store the workstation.

# INSTRUMENTATION

## INSTRUMENTATION SET

In addition to the mechanical instrumentation described in the Surgical Technique documents (TO.G.GB.021 for SCORE®, TO.G.GB.045 for SCORE® II, TO.G.GB.029 for Revision SCORE® and TO.G.GB.014 for ANATOMIC®), the following are required:

- \* AMPLIVISION® Navigation Station
- \* Sterile, single-use markers (14 per pack)
- \* the [AMPLIVISION® Navigation Set: 2-0299916](#)

### **AMPLIVISION Sterile Markers packaging per 14 (Product No. 3-0400902):**

- The arrays must be equipped with markers to be visible to the camera. These markers are attached through the nipples on the array (3 for the F, T and G arrays and 4 for the probe P).



### **Single-use Conical Threaded Pins AMPLIVISION® Ø4 length 150mm packaging per 4 (Product No. 2-0252200):**

4 Single-use Conical Threaded Pins AMPLIVISION Ø4 length 150mm packaging per 4, are available upon request. They are inserted in the femur and the tibia and Inclined fixation system, navigation geometry are placed on these pins which are inserted in the femur and the tibia.



Not all devices presented in this surgical technique are necessarily registered in your country. Please contact your Amplitude representative to find out if they are available.



# INSTRUMENTATION

## AMPLIVISION® NAVIGATION SET

2-0299916

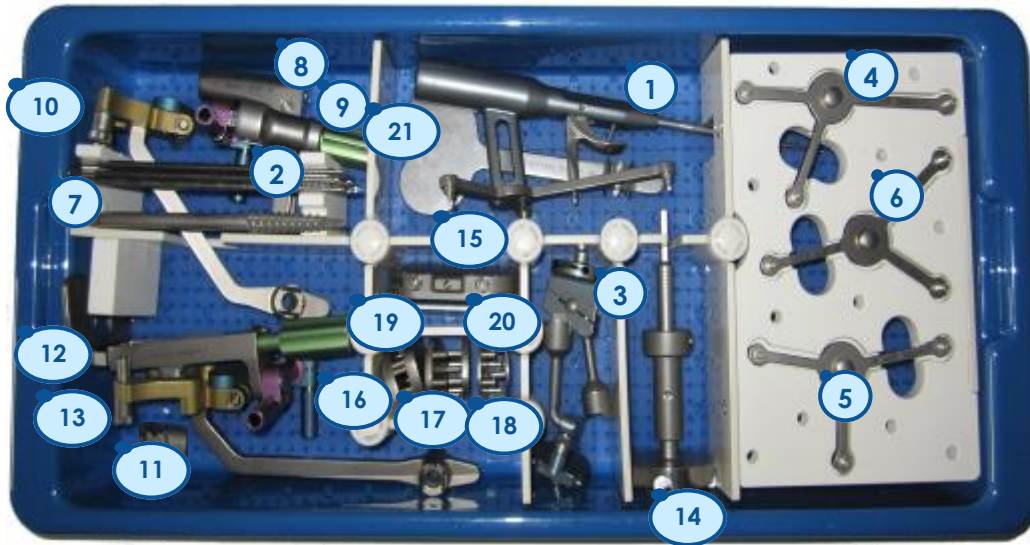

Item	Name	Product No	Qty
1	Probe knee navigation	2-0215700	1
2	Conical Threaded Pins AMPLIVISION Ø4 length 150mm	2-0235500	5
3	Inclined fixation system, navigation geometry	2-0117200	2
4	T array, tibia navigation	2-0215800	1
5	F array, femur navigation	2-0117400	1
6	G array, Instrumentation navigation	2-0117500	1
7	Tap for navigation	2-0207500	1
8	Navigated Tibial Arm	2-0210000	1
9	Alignment guide for tibial navigation	2-0209600	1
10	Guiding Sleeve - Tibial navigation	2-0207600	2
11	Removable valgus guide - Femoral navigation	2-0209800	1
12	Alignment guide for femoral navigation	2-0209700	1
13	Drill guide for pin Ø4	2-0203500	2
14	Distal femoral reamer	2-0210100	1
15	Spacer navigation	2-0211100	1
16	Half-wedge height 2 mm	2-0211202	2
17	Half-wedge height 4 mm	2-0211204	2
18	Half-wedge height 6 mm	2-0211206	2
19	Full wedge height 2 mm	2-0211302	1
20	Full wedge height 4 mm	2-0211304	1
21	Measuring Plate for Tibial Resection –Navigation	2-0217300	1

# INSTRUMENTATION

## INSTRUMENTS

### Probe knee navigation:

- This instrument is used to acquire specific points and areas on the patient's anatomical structures. It is also used to remotely control certain active elements on the screen. The probe must be fitted with four markers, one of them being on the trigger.

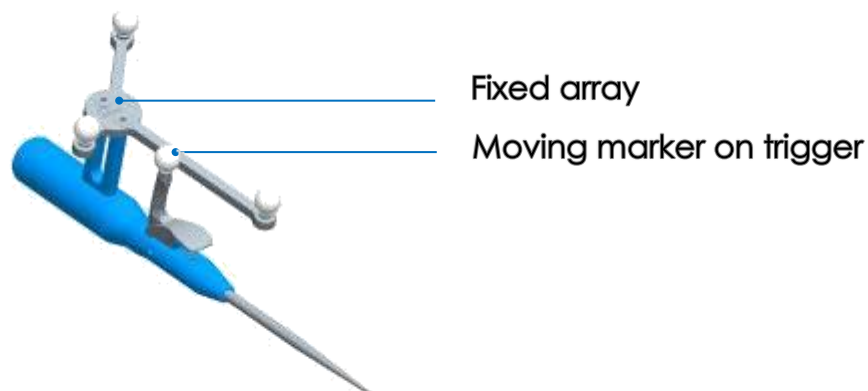

### Universal handle and measuring plate:

- The Universal Handle (for SCORE® baseplate), The tibial baseplate handle (for ANATOMIC® baseplate) and tibial cut measuring plate each have one or two attachment points for the G array (one on each side). The array can only be assembled in one direction into each attachment point.

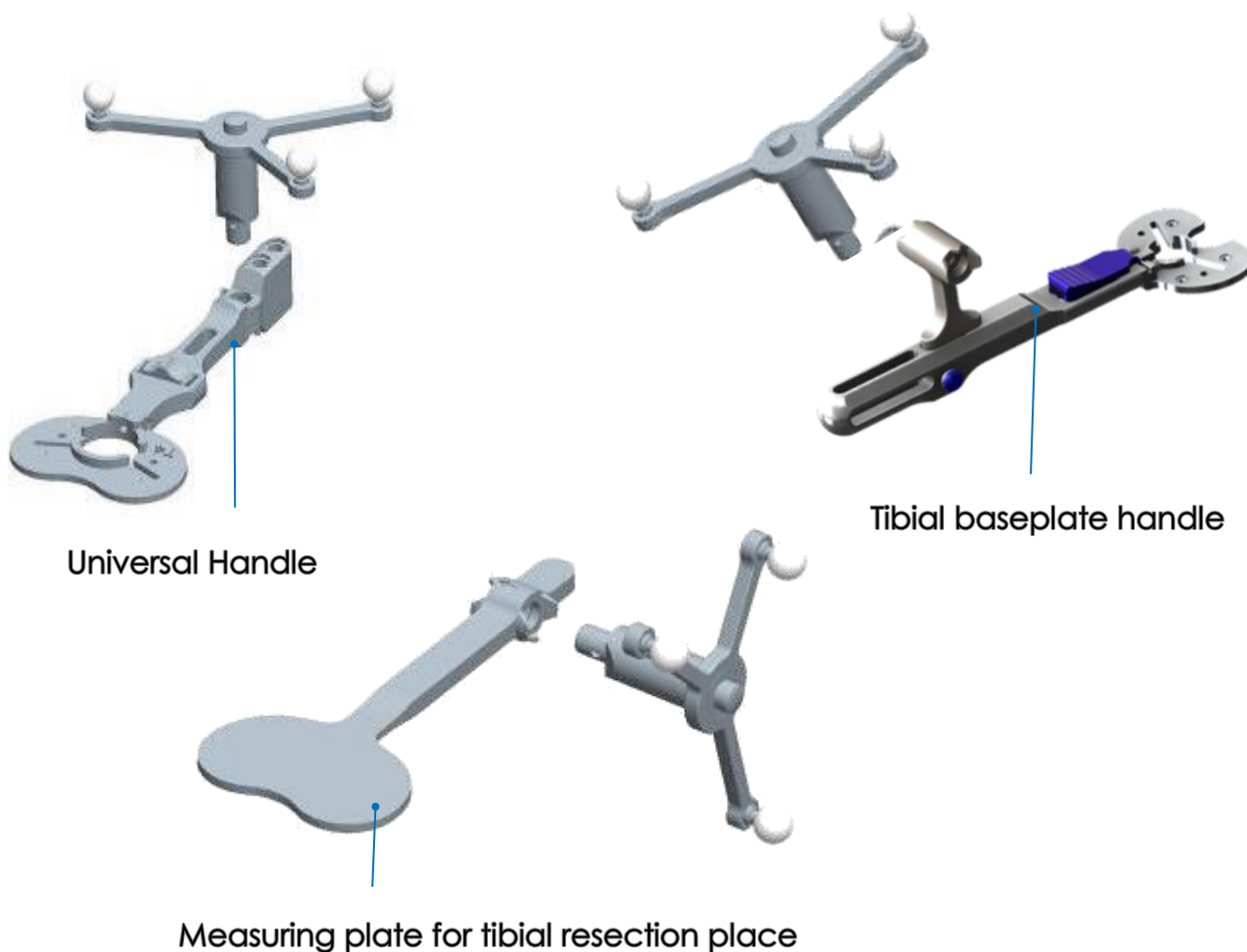

# APPENDIX A

## SCREEN LAYOUT

Implant and side selected

Title of current step

Screenshot capture button

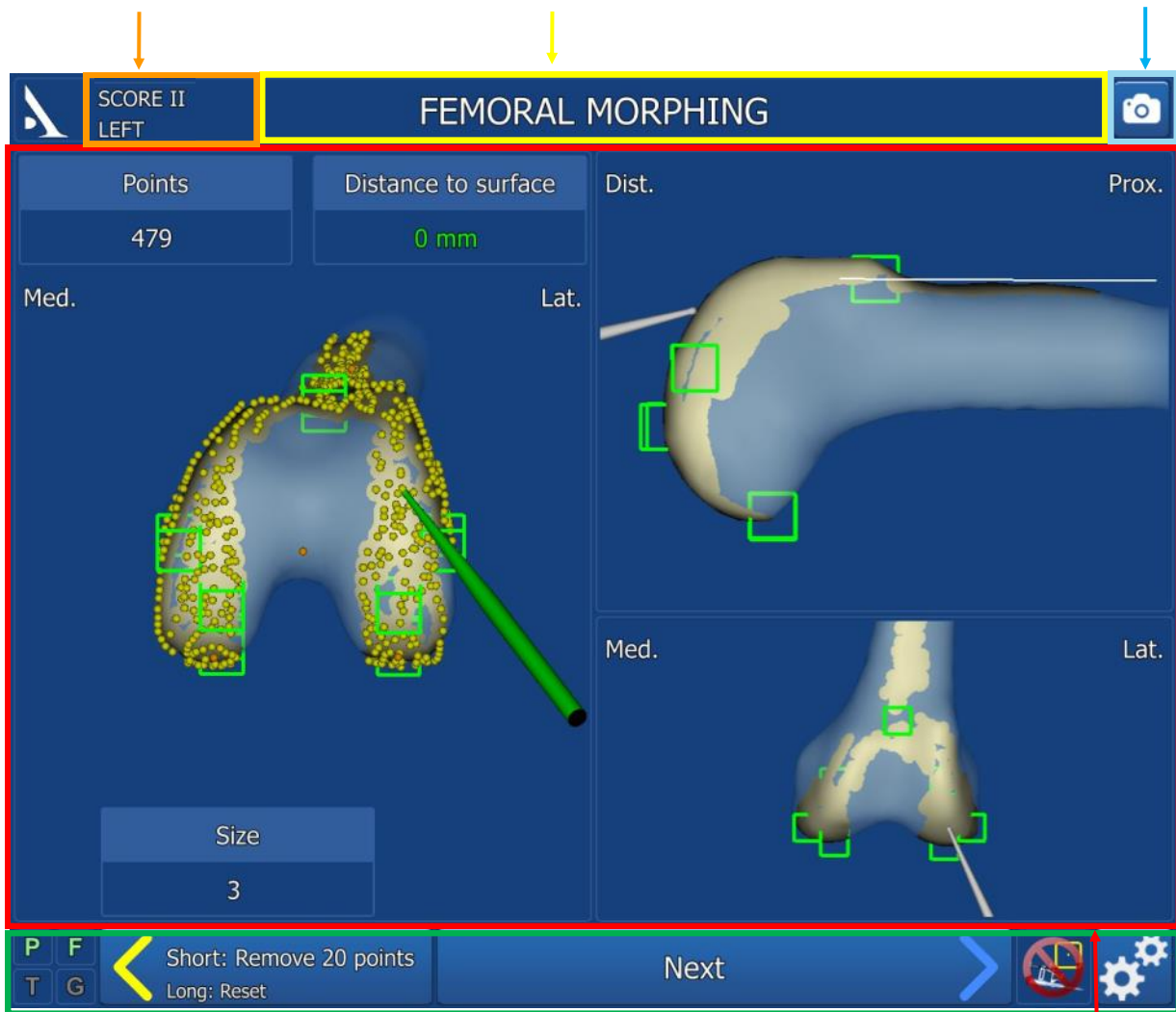

Information area and buttons

Active area

Yellow pedal: indicates action carried out when pedal is pressed

Blue pedal: action carried out when pedal is pressed

Menu: Options



Visibility of each array:  
Green - visible  
Red - not visible

Indicates if probe can be used as a mouse on screen

# APPENDIX B

## OPTIONS MENU DESCRIPTION

The « Exit Application » button will only be active during the final step  
To exit the application before the final step, go to the « Options » menu to select it

Change the type of implant

Show camera field of view to locate arrays

Reset navigation station position relative to surgeon position

View all the validated steps during the surgery

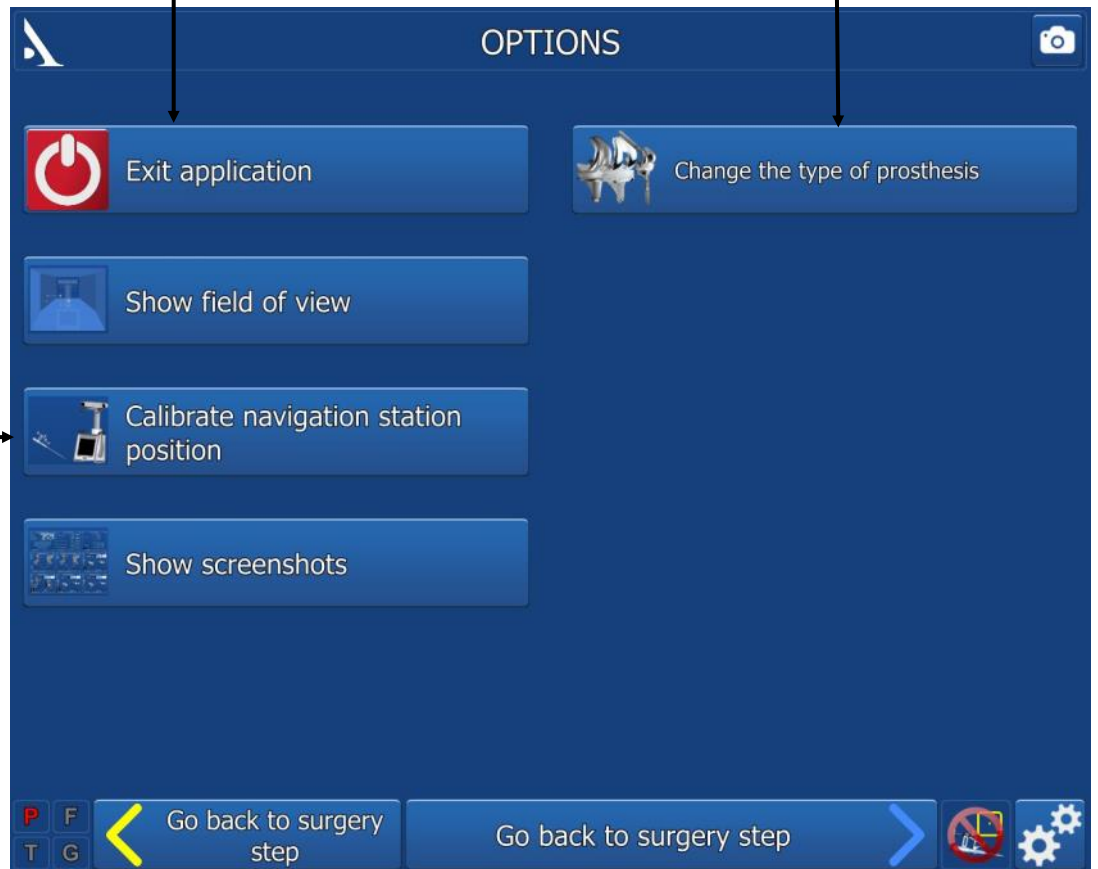

# APPENDIX C

## SAVING A USER PROFILE

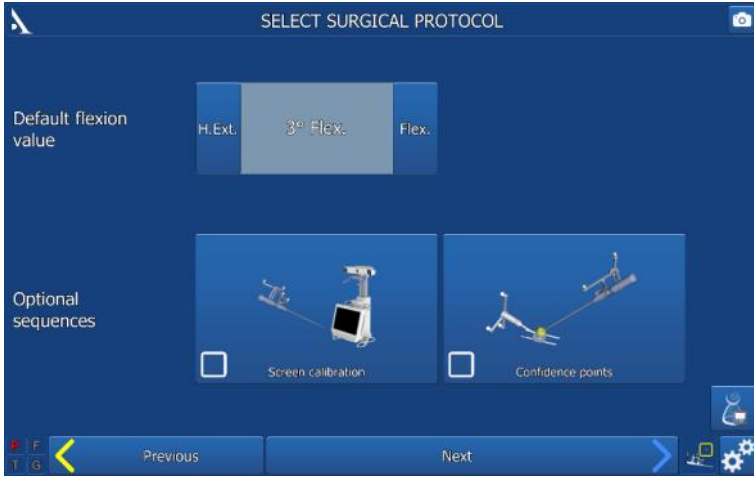

- Once the surgery-related options have been selected, a user profile can be created by pressing the « Save User Profile» button 
- The following information will be saved to a USB drive:
  - Surgeon name
  - Preferred tibial rotation reference
  - Preferred navigation method for tibial cut
  - Preferred trial implant acquisition order
  - The default flexion deformity value selected
  - The anatomical parameters and optional sequences selected.

## WORKING WITH USER PROFILES



Options that can be changed

- In future surgical procedures with navigation, plug in the USB drive to automatically load the surgeon's name and preferences.
- At this point, the software will go from the « Information » page to the « Camera Setup » page and will skip the « Surgery-related options » page.
- To change a saved parameter, press the  button at the lower right corner of the « Information » screen.

# APPENDIX D

## CHANGE OF PROSTHESIS



The surgeon can change to a different TKA implant during the procedure **up to the end of femoral planning step** (before any of the femoral cuts are carried out).

- Press the « Options » button 
- Press the « Change implant type ».

The selected implant is outlined in green.

- For example, select the SCORE® Revision TKA. Once it is outlined in green, press the blue pedal or blue arrow to return to the surgery.



### NOTE

If the implant is changed during the femoral planning step, an information box will appear indicating that the positioning parameters have been reset to the default position for the femoral component

# APPENDIX E

## OPENING A SAVED SURGERY REPORT

If a saved surgery report is not transferred to a USB drive, it can still be retrieved at a later date.

- Turn on the AMPLIVISION® workstation
- When the AMPLIVISION® welcome screen appears, press the button on the lower right of the screen 
- The message « Do you want to extract patient data? » will appear. Press « OK ».
- A calendar will appear. The dates on which surgery reports were saved will be highlighted in green. Select the dates corresponding to the procedure(s). For each date, AMPLIVISION® lists available reports in the « Surgeries to export » window.

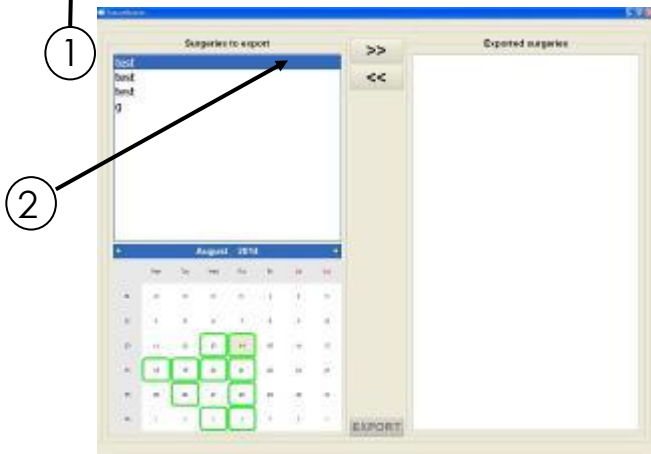
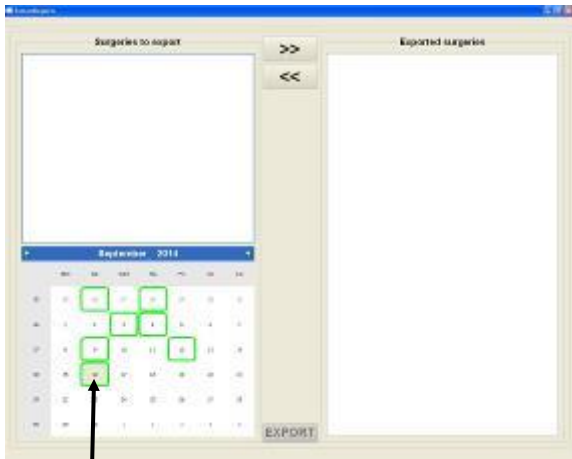

- Use the touch screen to select the reports to be exported and then press the **>>** button to move them to the « Exported surgeries » window.
- Insert the USB drive and press the **EXPORT** button to copy these reports to it. A message will appear when the operation is complete.

### NOTE

To ensure confidentiality, the exported reports are saved in an encrypted file format, « Report001.amplitudereport » on the USB drive. Contact AMPLITUDE to obtain access to the desired report

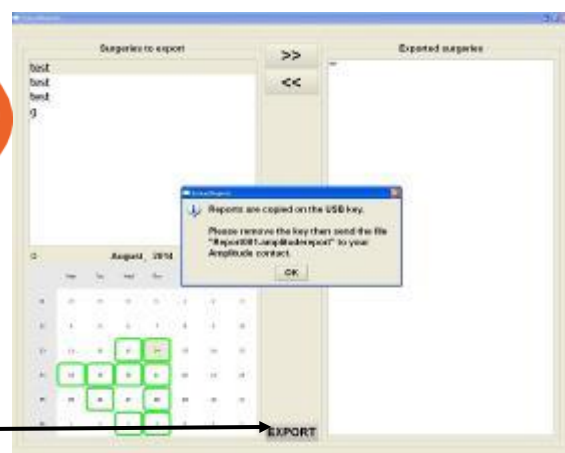
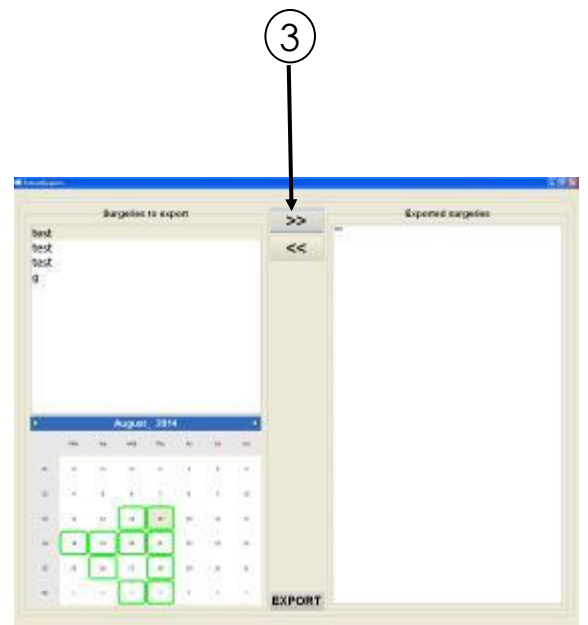

# APPENDIX F

## ASSEMBLY OF ALIGNMENT GUIDE FOR TIBIAL NAVIGATION

Make sure all dials are set to neutral before the procedure

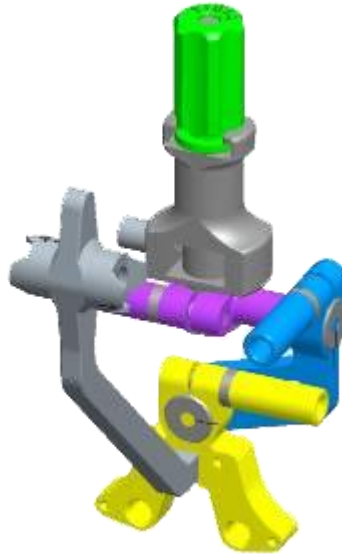

Insert thumb knob into slot



Tibial adjustment knob

5

Binding screw Tibial slide bar (purple)

3

Tibial slide bar

4

Arm (purple)

1

Return lever (blue)

6

Tibial translation shaft

2

Binding screw (blue)

7

Binding screw (yellow)

9

Tibial alignment guide (yellow)

8



# APPENDIX G

## ASSEMBLY OF ALIGNMENT GUIDE FOR FEMORAL NAVIGATION

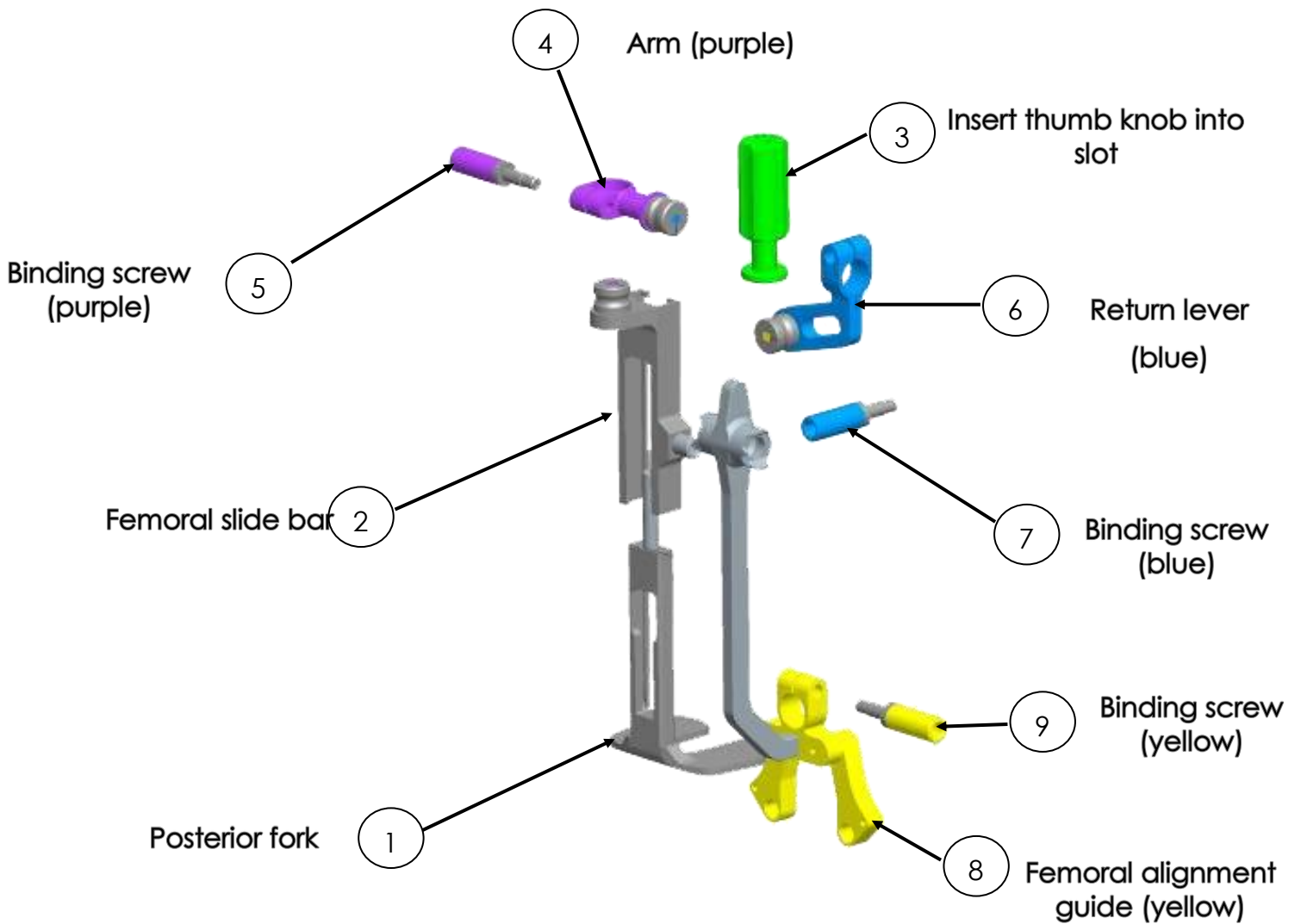
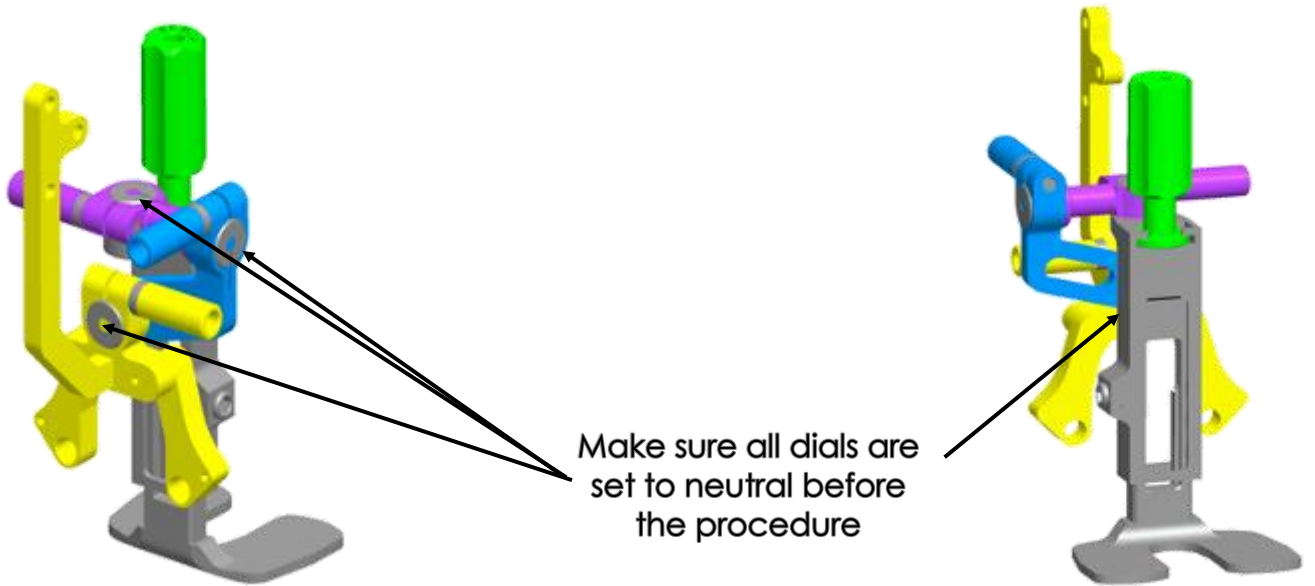



# NOTES

---

Blank lined area for notes.

**Customer Service - France:**

Porte du Grand Lyon,  
01700 Neyron, France  
Tel.: +33 (0)4 37 85 19 19  
Fax: +33 (0)4 37 85 19 18

**Customer Service-Export:**

11, cours Jacques Offenbach. ZA Mozart 2 ,  
26000 Valence, France  
Tel.: +33 (0)4 75 41 87 41  
Fax: +33 (0)4 75 41 87 42

E-mail: [amplitude@amplitude-ortho.com](mailto:amplitude@amplitude-ortho.com)

Internet: [www.amplitude-ortho.com](http://www.amplitude-ortho.com)